

	Page
● Introduction & Principal Uses .....	2
● Manufacturing .....	3
● Methods of Shipping Caustic Soda .....	4
● Safety in Handling Caustic Soda .....	5
● Unloading and Handling Liquid Caustic Soda ...	7
● Equipment for Handling Caustic Soda .....	14
● Technical Data .....	17
● Dilution Calculations .....	32
● Methods of Analysis .....	34

## Foreword

This handbook outlines the methods for handling, storing, preparing and using caustic soda. It includes information on the manufacture, physical properties, safety considerations and analytical methods for testing caustic soda.

Additional information and contacts can be found at [www.oxychem.com](http://www.oxychem.com)

Occidental Chemical Corporation (OxyChem)  
Basic Chemicals Group  
Occidental Tower  
5005 LBJ Freeway  
Dallas, TX 75244

"Important: The information presented herein, while not guaranteed, was prepared by technical personnel and is true and accurate to the best of our knowledge. NO WARRANTY OF MERCHANTABILITY OR OF FITNESS FOR A PARTICULAR PURPOSE, OR WARRANTY OR GUARANTY OF ANY OTHER KIND, EXPRESS OR IMPLIED, IS MADE REGARDING PERFORMANCE, SAFETY, SUITABILITY, STABILITY OR OTHERWISE. This information is not intended to be all-inclusive as to the manner and conditions of use, handling, storage, disposal and other factors that may involve other or additional legal, environmental, safety or performance considerations, and OxyChem assumes no liability whatsoever for the use of or reliance upon this information. While our technical personnel will be happy to respond to questions, safe handling and use of the product remains the responsibility of the customer. No suggestions for use are intended as, and nothing herein shall be construed as, a recommendation to infringe any existing patents or to violate any Federal, State, local or foreign laws."

Caustic soda (sodium hydroxide or NaOH) is most commonly manufactured by the electrolysis of a sodium chloride (NaCl) solution. OxyChem manufactures caustic soda using either membrane or diaphragm electrolytic cells. OxyChem does not use mercury based electrolytic cells to produce caustic soda. The co-products formed from the electrolytic production of caustic soda are chlorine and hydrogen.

The largest users of caustic soda are the pulp and paper, detergent and chemical industries. Caustic soda is also used in the alumina, oil and gas and textile industries, mostly for its alkalinity value.

OxyChem has played a leading role in providing caustic soda to meet the increasing demands of industry. OxyChem plants are strategically located to conveniently and economically serve industry.

Terminals are used to maintain stocks of our caustic soda in many principal cities. Distributor stocks are also available in these and many other cities and form a network of supply for the end user's convenience.

Liquid caustic soda is available as a 50% solution in two main grades. The name of the grades corresponds to the equipment used to produce the caustic soda; membrane grade and diaphragm grade. Specification sheets for each grade can be found on our website at [www.oxychem.com](http://www.oxychem.com)

To be technically correct, only molten caustic soda should be called liquid, but since the term liquid caustic soda has historically been used to describe solutions of caustic soda, it is used in this document interchangeably with the term solution.

OxyChem produces caustic soda at the following locations:

- Battleground, TX (Diaphragm)
- Convent, LA (Diaphragm)
- Geismar, LA (Membrane and Diaphragm)
- Ingleside, TX (Diaphragm)
- Niagara Falls, NY (Diaphragm)
- Taft, LA (Diaphragm)
- Wichita, KS (Membrane and Diaphragm)

## Principal Uses and Consumption of Caustic Soda

Caustic soda is one of the very few chemicals utilized in a very broad range of applications. Some principal products or processes in which caustic soda is used are:

- Acid Neutralization
- Agricultural Chemicals
- Aluminum
- Battery Recycling
- Bleach
- Boiler Compounds
- Cellulose Film
- Chemicals:
  - Ammonia
  - Amyl Amines
  - Cresol
  - Ethylene Amines
  - Formic Acid
  - Glycerine

- Maleic Anhydride
- Pentaerythritol
- Phenol
- Propylene Oxide
- Polycarbonates
- Salicylic Acid
- Sodium Aluminate
- Sodium Hydrosulfide
- Sodium Hypochlorite
- Sodium Phosphates
- Styrene
- Vinyl Chloride Monomer
- Cleaning Formulations
- Corn Syrup
- Detergents
- Drain Cleaners
- Dyestuffs
- Ethanol Fermentation
- Food Processing
- Fruit & Vegetable Peeling

- Glass-Batch Wetting
- Ion-Exchange Resin Regeneration
- Metal Production and Casting
- Ore Flotation and Processing
- Paint Removers
- Petroleum Refining
- pH Adjustment
- Pharmaceuticals
- Pigments
- Pool & Spa chemicals
- Pulp & Paper
- Rayon
- Silicates
- Soap
- Surfactants
- Textile Bleaching, Dyeing, and Mercerizing
- Vegetable Oil Processing
- Water Treatment

Caustic soda is produced by OxyChem by an electrolytic process as shown below. Brine, prepared from sodium chloride (NaCl), is electrolyzed in either a membrane cell or a diaphragm cell. The production of caustic soda (NaOH) also results in the co-products of chlorine and hydrogen.

In the membrane process, a solution of approximately 30% in strength is formed. The solution is then sent to evaporators, which concentrate it to a strength of 50% by removing the appropriate amount of water.

The diaphragm process is very similar to the membrane process except that a solution of only 10-12% is formed in the cell. Therefore, additional evaporation is required to reach the saleable concentration of 50%.

The caustic soda solution is inventoried in storage tanks prior to shipment. The product is shipped in tank trucks, railcars, barges and ships.

The major difference in the two grades is the amount of starting material (sodium chloride) remaining in the final product. Membrane grade caustic soda will have less than 100ppm of the sodium chloride remaining in the product. Diaphragm grade material will have less than 1.2% sodium chloride. Several other differences can be seen in the products when the specification sheets are compared.



### Production Flowcharts

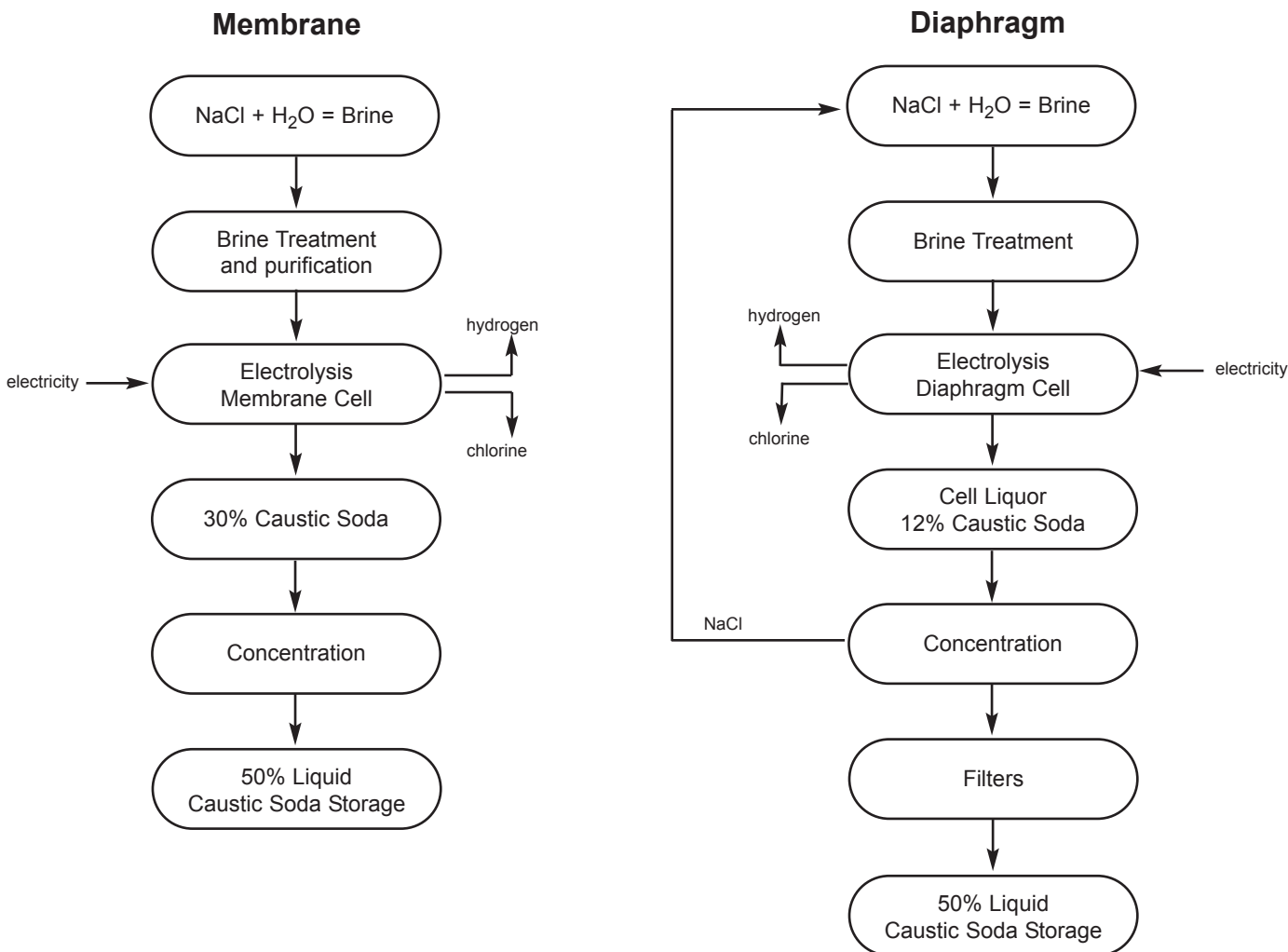

# Methods of Shipping Liquid Caustic Soda

Liquid caustic soda is available from OxyChem's many plants and terminals in tank truck, tank car, barge and ship quantities. Each form of transportation has its own advantages. The type of service selected will depend upon such factors as size and location of storage, rate of consumption, plant location, freight rates, etc.

Caustic soda, liquid, is regulated by the U.S. Department of Transportation (DOT) and is classified as a corrosive material.

The DOT identification number is UN 1824 for liquid caustic soda.

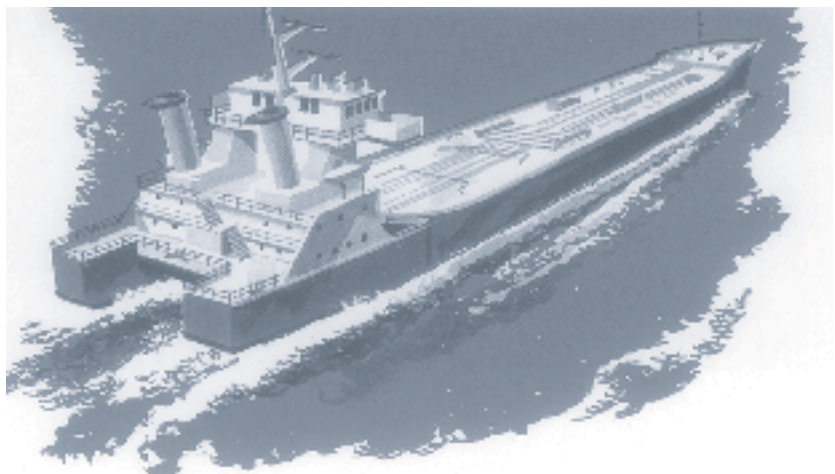

# Safety in Handling Caustic Soda

**Caustic soda in any concentration must be respected by everyone who handles and uses it. Before starting to work with it, the user should be aware of its properties, know what safety precautions to follow, and know how to react in case of contact. Accidental exposure to caustic soda may occur under several conditions. Potentially hazardous situations include handling and packaging operations, equipment cleaning and repair, decontamination following spills and equipment failures. Employees who may be subject to such exposure must be provided with proper personal protective equipment and trained in its use. Some general guidelines follow.**

- Read and understand the latest Material Safety Data Sheet.
- Provide eyewash fountains and safety showers in all areas where caustic soda is used or handled. Any caustic soda burn may be serious. DO NOT use any kind of neutralizing solution, particularly in the eyes, without direction by a physician.
- Move the patient to a hospital emergency room immediately after first aid measures are applied.

## FIRST AID MEASURES

**For Eyes:** If for any reason caustic soda contacts the eyes, flood the eyes immediately with plenty of clean water. Continue flushing for at least 15 minutes. While flushing, forcibly hold the eyelids apart to ensure rinsing of the entire eye surface. **Do not use any kind of neutralizing solution in the eyes.**

**GET MEDICAL ATTENTION IMMEDIATELY.**

**For skin:** If caustic soda comes in contact with skin or clothing, flush with plenty of clean water for at least 15 minutes. Remove contaminated clothing and footwear. Thoroughly wash affected clothing and rubber/vinyl footwear. Discard contaminated leather footwear.

**GET MEDICAL ATTENTION IMMEDIATELY.**

**For inhalation:** If a worker is overcome due to the inhalation of caustic soda dust, mist or spray, remove them from the contaminated area to fresh air. If breathing is difficult, have a trained person administer oxygen. If breathing has stopped, have a trained person administer artificial respiration.

**GET MEDICAL ATTENTION IMMEDIATELY.**

**For ingestion:** Although it is unlikely in an industrial situation that caustic soda would be ingested, it could be swallowed accidentally. If that occurs, DO NOT induce vomiting. Give large quantities of water. If vomiting occurs spontaneously, position individual's head to keep airway clear. NEVER give anything by mouth to an unconscious person. **GET MEDICAL ATTENTION IMMEDIATELY.**

## PROTECTIVE EQUIPMENT

OSHA requires employers to supply suitable protective equipment for employees. When handling caustic soda, the following protective equipment is recommended:

- **Wear suitable chemical splash goggles for eye protection during the handling of caustic soda in any concentration.** The goggles should be close-fitting and provide adequate ventilation to prevent fogging, without allowing entry of liquids.

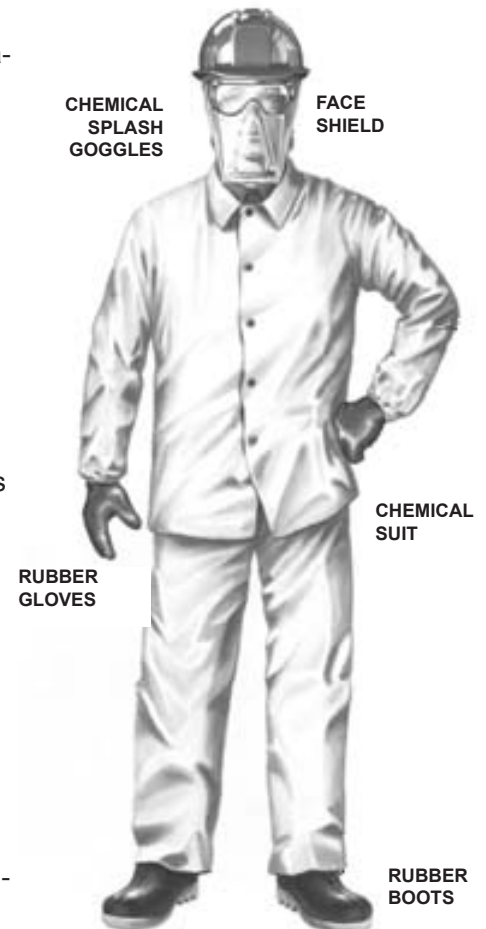

- The use of a face shield may be appropriate when splashing can occur, including loading and unloading operations.
- Wear rubber gloves or gloves coated with rubber, synthetic elastomers, PVC, or other plastics to protect the hands while handling caustic soda. Gloves should be long enough to come well above the wrist. Sleeves should be positioned over the glove wrists.
- Caustic soda causes leather to disintegrate quite rapidly. For this reason, wear rubber boots. Wear the bottoms of trouser legs out-

- side the boots. DO NOT tuck in.
- Wear chemical resistant clothing for protection of the body. Impregnated vinyl or rubber suits are recommended.
  - Wear hard hats for some protection of the head, face and neck.
  - If exposures are expected to exceed accepted regulatory limits or if respiratory discomfort is experienced use a NIOSH approved air purifying respirator with high efficiency dust and mist filters.

## PROTECTIVE PRACTICES

- Avoid breathing dust, mist or spray of caustic soda.
- Wear proper protective equipment. If warranted, wear approved respiratory protection.
- Keep equipment clean by washing off any accumulation of caustic soda.
- Weld pipelines where practical. Use flanged joints with gaskets made of caustic soda resistant material such as rubber, PTFE, or EPDM rubber. If a screwed fitting is used, apply Teflon<sup>®</sup> tape to the threads.
- When disconnecting equipment for repairs, first verify that there is no internal pressure on the equipment and that the equipment has been drained and washed.
- Provide storage tanks with suitable overflow pipes. Overflow pipes should be directed near the bottom of the diked area.
- Shield the packing glands of pumps to prevent spraying of caustic solutions in the event of a leak.
- When releasing air pressure from a pressurized system, take every precaution to avoid spurts or sprays of caustic solution.

- When making solutions, **always** add the caustic soda slowly to the surface of the water with constant agitation. **Never add the water to the caustic soda.** Always start with lukewarm water (80-100°F). Never start with hot or cold water. Dangerous boiling or splattering can occur if caustic soda is added too rapidly, allowed to concentrate in one area or added to hot or cold liquids. Care must be taken to avoid these situations.
- In case of a spill or leak, stop the leak as soon as possible. After containment, collect the spilled material and transfer to a chemical waste area. Remove large liquid spills by vacuum truck. Neutralize residue with dilute acid. Flush spill area with water and follow with a liberal covering of sodium bicarbonate or other acceptable drying agent.

## HANDLING LIQUID CAUSTIC SODA

In handling caustic soda solutions, care must be taken to avoid solidification which will plug pipelines and equipment. Graph 1 (pg. 29) shows the freezing points for solutions of caustic soda at various concentrations.

Should a caustic soda solution become frozen in process equipment or piping, care must be taken when thawing the material. Use only low pressure (10 PSIG or less) steam. Accelerated corrosion can occur in areas where equipment is subjected to extremely high temperatures.

# Unloading and Handling Liquid Caustic Soda in Tank Cars

## GENERAL INFORMATION

Caustic soda in liquid form has a markedly corrosive action on all body tissue. Even dilute solutions may have a destructive effect on tissue after prolonged contact. Inhalation of concentrated mists can cause damage to the upper respiratory tract, while ingestion of liquid caustic soda can cause severe damage to the mucous membranes or other tissues where contact is made. In addition, considerable heat is generated when liquid caustic soda is mixed with water which can result in boiling or splattering. When diluting, always add caustic soda to water; never add water to caustic soda.

It is important that those who handle caustic soda are aware of its highly reactive and corrosive properties and know what precautions to take. In case of accidental exposure, immediately flush exposed area with large amounts of water and seek medical attention. For more specific information refer to the Safety in Handling Caustic Soda section of this handbook and to the MSDS.

## PLACEMENT OF THE CAR FOR UNLOADING

1. After the car is properly spotted, DOT regulations require that the hand brake be set and the wheels blocked before any connections are made.
2. Caution signs must be placed at both ends of the car being unloaded to warn people and switching crews approaching the car. DOT regulations state that caution signs must be placed on the track or car to give warning to persons approaching the car from the open end or ends of siding. Caution signs must be left up

until the car is unloaded and disconnected from the discharge connections. Signs must be made of metal or other suitable material, at least 12x15 inches in size, and bear the words, "STOP-TANK CAR CONNECTED", or "STOP-MEN AT WORK."

3. It is recommended that derail attachments be placed at the open end or ends of siding, approximately one car length away.
4. Before hooking up a car, the responsible individual should first locate and test the nearest eyewash and safety shower. Purge water through each to remove rust that may have accumulated.

## UNLOADING PRECAUTIONS

1. Only responsible and well supervised employees should be entrusted with the unloading of liquid caustic soda. Unloading operations must be monitored while the car is connected.
2. Since serious burns can result from contact of caustic soda with the skin and eyes, workers should be well protected and cautioned to exercise care. Persons hooking up a car should wear the following personal protective equipment:
  - Hard hat
  - Chemical splash goggles
  - Face shield
  - Rubber, steel-toed boots
  - Rubber gloves or equivalent
  - Vinyl or rubber jacket and pants
  - If warranted, wear approved respiratory protection

3. A car of caustic soda should be unloaded only when adequate lighting is available throughout the entire unloading process.
4. Before starting to unload, make certain that the tank car is vented and that the storage tank is vented and has sufficient capacity.
5. No one should enter the car under any circumstances.
6. If a tank car needs to be moved when partially unloaded, DOT regulations require that all unloading lines must be disconnected and car closures must be replaced.
7. A suggested method for sampling is to draw intermittent samples from a 1/2" sample line, connected to a vertical section of the unloading line. The sample line should be fitted with a valve and a 1/4" nipple.
8. OxyChem's liquid caustic soda is shipped in well insulated and specially lined tank cars. Linings in these tank cars will withstand temperatures up to 225°F. Recommended steam pressure used to heat up a rail car is limited to 10psig max due to this fact. To prevent damage to the linings, neither water nor steam should be added directly into the tank cars if the car contains a level of caustic.
9. Unloading lines should be covered with suitable insulation and heated just prior to transfer of liquid caustic soda to storage. The preferred method of heating is to provide electric or steam heat tracing around the unloading line, under the insulation. An alternate method is to provide tees in the unloading line so that steam (or hot water) can be run through the unloading line just prior to its use.

These precautions will prevent the solidification of liquid caustic soda in cold unloading lines.

***Running steam through unloading lines will increase corrosion in unlined steel piping systems and iron pickup in the product.***

10. If compressed air is used in unloading operations, it is important that all fittings be inspected for leaks or other defects before unloading. Dome fittings in particular should be inspected. If leaks are found, unloading operations should be suspended until they are corrected.
11. General purpose caustic rail car tanks are structurally designed and constructed for 100 psig, and have a design burst rating of 500 psig. Per 49 CFR 179 and the AAR Specifications for Tank Cars, a pressure relief device is installed sized for a fire scenario, that is set for 75 to 165 psig. The higher set pressure is allowed due to the premature failure of the lower rated relief devices that occurred during transport handling, and resulted in injuries to rail road personnel. Even through they are designed and equipped as such, these are NOT pressure rail cars, nor should they be padded above what OxyChem and the Chlorine Institute recommends (20-25 psig). After a rail car is loaded with product, it is leak checked at approx 30 psig to meet the DOT shipping requirement, and that test pressure is released prior to shipping. Because of inherent shaking and jarring experienced by the rail car and contents during the shipping process, gaskets and joints can loosen up and customers should be cautious of that possibility. If pressure

unloading, particular areas to watch are the manway gasket, the bottom flange gasket (when bottom unloading), and the top operator gland area for bottom outlet valve (if so equipped). Additionally the top operated bottom outlet valve reach rods can in rare instances, come detached during transit, and there have been reports that these rods can be 'pushed up' from a rail car if unloading pressures > 30 psig are used.

## HANDLING IN COLD WEATHER

Since OxyChem tank cars are well insulated and liquid caustic soda is loaded hot, it usually arrives at its destination in a liquid condition. However, since 50% liquid caustic soda begins to crystallize at 54°F, in cases of unusual delays in transit, freezing may take place in cold weather. If freezing has occurred, the following procedure should be used.

1. Carefully open tank car dome cover.
2. If a layer of caustic soda has formed over the contents of the car, this crust should be broken before admitting steam to the jacket around the bottom discharge valve. The puncturing of the crust permits expansion of the liquid as it increases in temperature.
3. If no crust is present, determine if crystals have formed on the bottom of the car by probing the bottom with a rubber-capped rod introduced through the dome opening.
4. If freezing has occurred, connect a steam line (10 psig or less) to the jacket around the bottom discharge valve. Connect a condensate return line at the valve jacket steam outlet. If a condensate return line is not used, it is advisable to connect a valve at the steam

outlet, which should be opened sufficiently to relieve condensate and direct it toward the ground or into a sewer. As contents liquefy, the valve may be closed further to conserve steam.

5. If necessary, steam can be connected to the rail car steam coils. A condensate return line, pressure reducing valve, and/or steam trap should be used. Do not exceed a steam pressure of 10 psig. Using steam pressure above 10 psig may damage the railcar lining.
6. The amount of material that is frozen in a caustic soda rail car is dependent upon the outside temperature, wind chill, and the time between when the rail car is loaded and unloaded. Although it is unlikely, it is possible for a caustic soda rail car to be totally frozen. If the caustic soda in a rail car is totally frozen, it may be necessary to apply steam to the rail car jacket for two days (48 hours) to liquefy all of its contents.
7. When examination indicates that the contents have liquefied and operation of the valve rod shows that the bottom discharge valve is free, the caustic soda is ready for unloading.  
***The unloading temperature of 50% caustic soda should be less than 120°F to minimize corrosion of unlined steel piping systems and equipment.***
8. If the above measures do not liquefy the contents on the car, contact your OxyChem representative.



# Rail Car Drawing Details of Caustic Soda Car

Figure 1

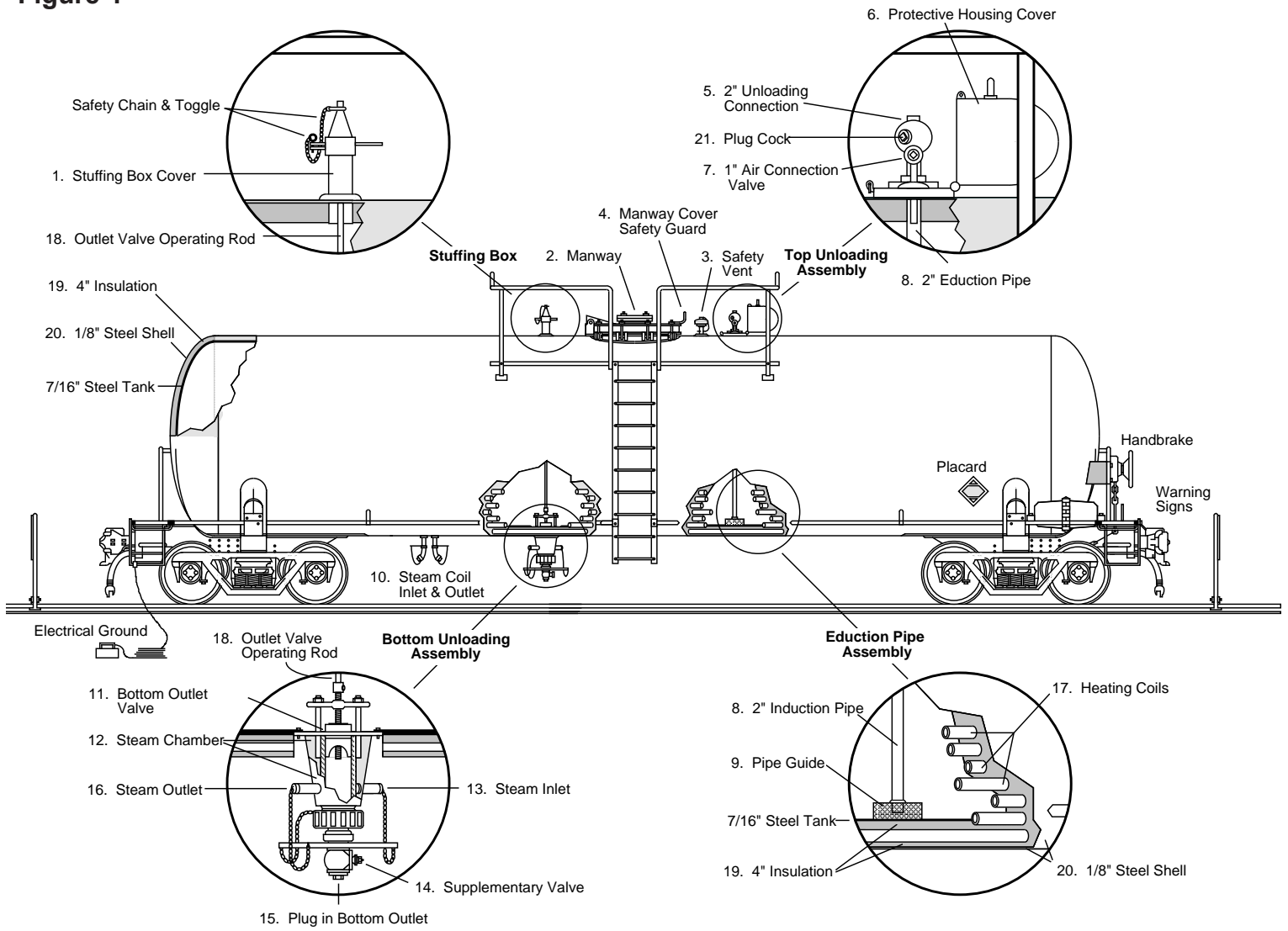

# Unloading Liquid Caustic Soda in Tank Cars

Rail cars can be either bottom unloaded (gravity, pump or pressure) or top unloaded (with air pressure). Refer to appropriate unloading procedure based on the method to be employed.

## UNLOADING THROUGH BOTTOM OUTLET VALVE

1. Open the dome cover and determine if the contents of the car are liquid. If not, see "Handling in Cold Weather." Keep the dome cover at least partially open during the entire unloading operation to vent the tank car.
2. Refer to Figure 1. Insure that the bottom outlet valve is closed tightly. The valve rod which operates the bottom discharge valve has a handle on it which is located outside the dome of the car. The handle can be reversed and serves as a cap in transit.
3. Remove the pipe plug, then carefully open the supplementary valve to drain any liquid that may have seeped past the bottom outlet valve during transit. If the supplementary valve cannot be opened, the application of steam from a steam lance, directed on

the valve, should free it for opening.

4. Attach the unloading line to the bottom of the supplementary valve.
5. Check the unloading line to see that all valves are in the proper position for unloading.
6. Open the bottom outlet valve by turning the valve rod to allow contents to flow by gravity to pump or tank. If the bottom outlet valve does not open upon application of light pressure, frozen caustic soda is probably present in the bottom of the car. Application of steam to the heat coils may be necessary. See "Handling in Cold Weather."
7. Compressed air can be used to increase the flow rate of caustic soda to storage or to transfer liquid without the use of a pump. If compressed air is to be used, check the rupture disk in the dome to be sure it is intact. Close the dome cover securely. Remove the one-inch air inlet plug and connect a flexible air line at this point. The air line should have a release valve, oil trap, pressure relief valve set at

20 PSIG, pressure reducing valve set at 18 PSIG and a shut-off valve. Apply air pressure to the car slowly. Note that the pressure relief device (rupture disk and/or pressure relief valve) in the dome will relieve at a pressure between 75 PSIG and 165 PSIG, depending on the type of car. Refer to the stenciling on the side of the railcar.

8. When the car and unloading line are empty, shut off air supply and open the release valve.
9. When the tank car is empty and the discharge pipe has completely drained, disconnect the air line, if used, close the bottom outlet valve and supplementary valve, and detach the unloading line at the car.
10. Prepare the car for return.

Figure 2: Bottom Unloading

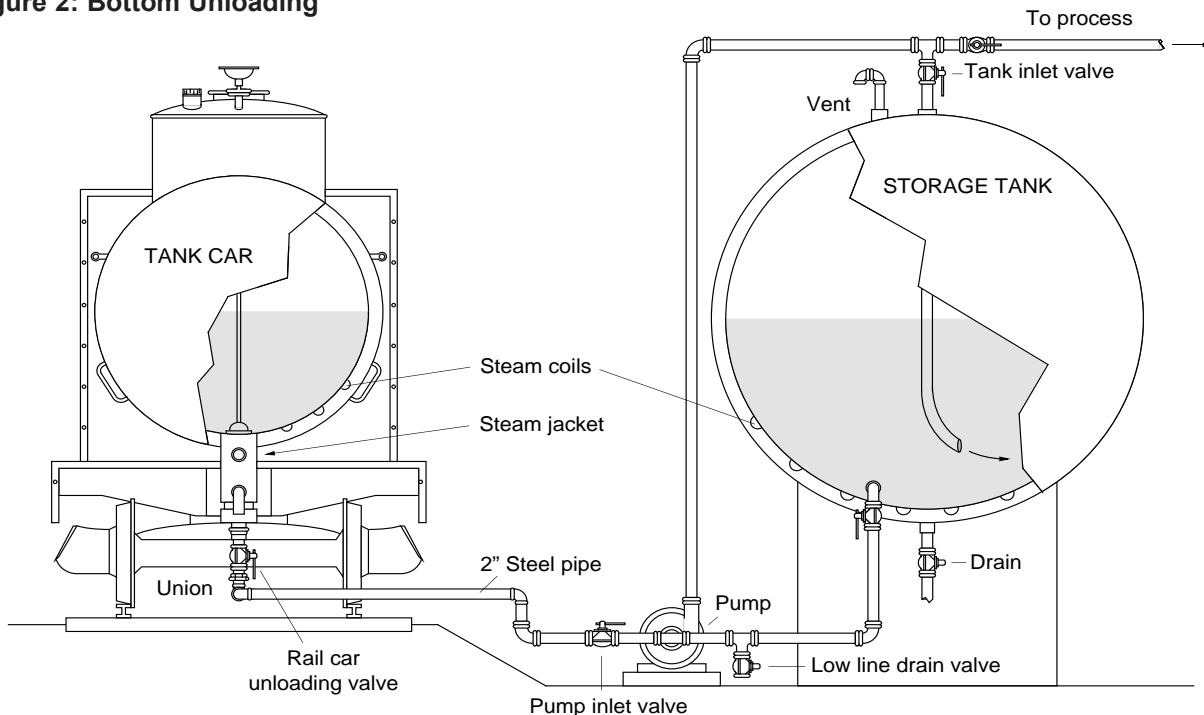

# Unloading Liquid Caustic Soda in Tank Cars

## UNLOADING THROUGH DOME WITH AIR PRESSURE

1. Open the dome cover to determine if the contents of the car are liquid. If not, see "Handling in Cold Weather."
2. Close the dome cover and fasten securely, making certain that it is air tight. Check that the rupture disk in the dome is intact.
3. Check that the product storage tank is vented and has sufficient capacity.
4. After opening the protective housing cover, connect the unloading line to the two-inch top unloading valve. After removing the protective housing cover, a flexible steel hose connection for the unloading line is recommended since a car may rise as much as 2" during unloading.
5. Connect the flexible air supply line to the one-inch air inlet valve. This line should have a release valve, oil trap, pressure relief valve set at 20 PSIG, pressure reducing valve set at 18 PSIG and a shut-off valve. Note that the relief device (rupture disk or pressure relief valve) in the dome will relieve at a pressure between 75 and 165 PSIG, depending on the type of car. Refer to the stenciling on the side of the railcar.
6. Apply air pressure slowly until there is a normal flow of liquid to the storage tank. The pressure should be adjusted and maintained until the tank car is completely empty. A drop in air pressure or the sound of air rushing through the unloading line indicates that the tank car is empty.
7. Shut off the air supply, open the release valve, and allow the eduction pipe to drain.
8. When the eduction pipe has drained and the tank car is at atmospheric pressure, disconnect the air supply line at the car.
9. Do not enter the car to make an inspection.
10. Open the dome cover and determine if the car is empty. If empty, disconnect the unloading line at the car, replace pipe plugs and tightly replace the dome cover and the protective housing cover.
11. Care should be taken not to spill

caustic soda on the car, since it will cause damage to the car and may endanger workers handling the empty car on its return.

12. Prepare the car for return.

## PREPARING EMPTY TANK CARS FOR RETURN

1. Make sure the bottom outlet valve and supplementary valve are closed.
2. Disconnect the unloading line and replace the bottom outlet plug. Do not replace closures on steam openings.
3. Close dome cover and fasten securely.
4. Return the empty tank car promptly in accordance with the shipper's instructions. The shipper's routing directions must be followed in all instances.

Figure 3: Top Unloading

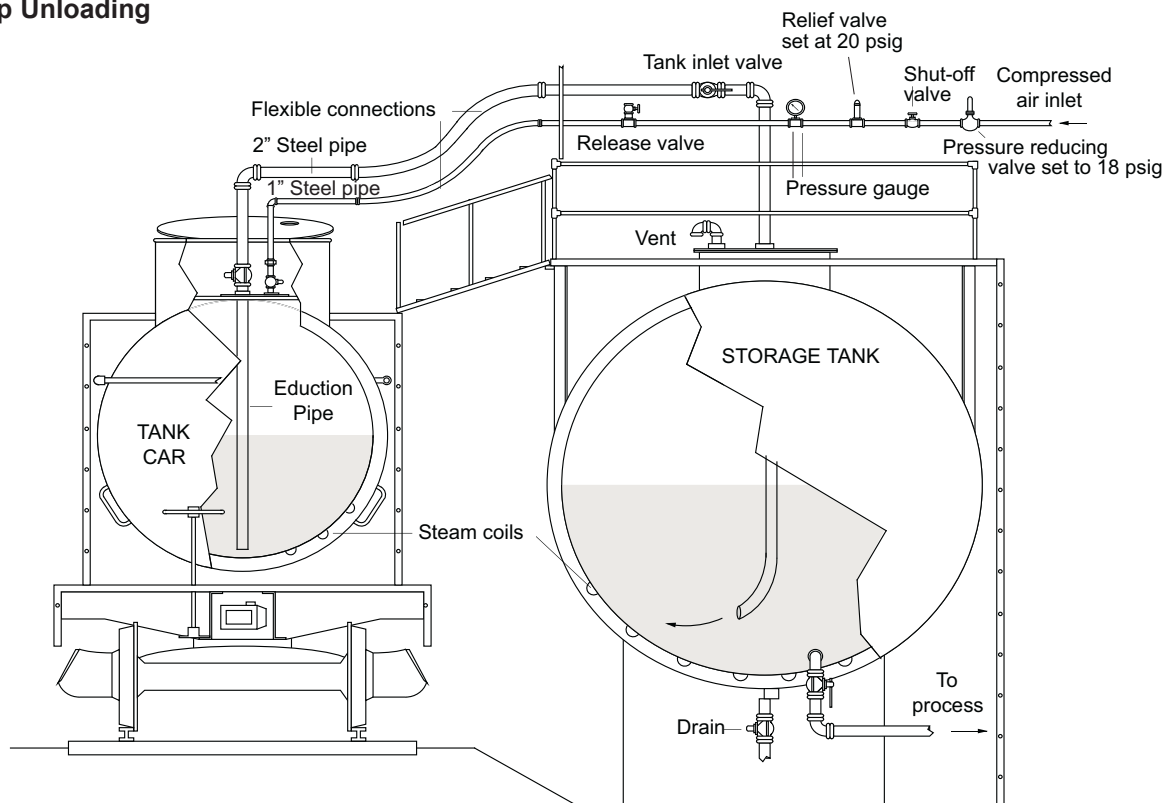

# Unloading Liquid Caustic Soda in Tank Trucks

12 of 44

## CARRIER RESPONSIBILITIES

OxyChem tank truck drivers have received instructions regarding equipment and delivery procedures. If an OxyChem arranged carrier, delivering caustic soda to your plant, fails to adhere to the following guidelines, please contact OxyChem so that corrective action can be taken.

### Equipment

Equipment must meet Department of Transportation regulations, Code of Federal Regulations (CFR), Title 49.

### Tank Truck Specification

Tank trucks should meet the established DOT requirements for hauling liquid caustic soda.

Four DOT "CORROSIVE" placards must be permanently affixed to the cargo tank.

### Unloading Equipment

If unloading is by gravity to storage or customer's unloading pump, no special equipment is needed.

If unloading is by truck-mounted pump, use only an all iron or nickel unit. The pump can be driven by a tractor powered take-off or an auxiliary gasoline engine. Use at least a 2-inch pump line.

If unloading is by compressed air, the tank vessel must meet the DOT requirements of the CFR, Title 49. The line used to supply air to the tank truck is required to be equipped with: pressure reducing valve, pressure release valve, pressure gauge, pressure reducing valve and pressure relief valve. The relief valve should be set at a maximum pressure of 20 PSIG and the pressure reducing valve should be set at 2 to 3 pounds lower. Whether this equipment is attached permanently to the tank or carried as an assembled unit to be attached at each unloading, it should be properly maintained and periodically tested.

A 40 foot length of air hose is required if the customer's air supply is used. When compressed air is not available from the customer's plant, trucks equipped with pumps or air compressors can be provided at the customer's request.

### Unloading Lines

Unloading hoses must be constructed of material resistant to caustic soda. Hoses should be at least 2 inches in diameter and 15 to 30 feet in length.

Whether the unloading hose is fitted with a union, pipe flange, or a quick type coupler, the truck driver should have available matching fittings and tools to facilitate a connection to a 2-inch or 3-inch threaded pipe.

## TRUCK DRIVER RESPONSIBILITIES

Truck drivers must obtain permission to unload from the proper authorities and observe any special instructions from the customer.

Truck drivers must wear the protective equipment required by OxyChem as listed under Protective Equipment, (pg. 6) or by customer, whichever is more inclusive, and at all times follow safe handling practices. Customers must not allow truck drivers who do not meet these requirements to unload.

### The following unloading procedures are recommended:

- Check the operation of the safety shower and eyewash fountain. Purge water through each to remove rust that may have accumulated.
- If a shower and eyewash are not available, a water hose connected to a source of water is required. If the valve on the line is not conveniently located near the unloading area, leave a stream of water flowing during unloading.
- Connect one end of the unloading hose to the customer's storage tank fill line.
- During cold weather and if facilities are provided, preheat with steam the fill line, the unloading hose, and, if needed, the truck outlet.
- Check the unloading line to be sure that it is open.
- Connect the unloading hose to the discharge outlet on the tank truck.
- Start the pump or start pressurizing the tank, depending on the type of equipment used.
- Open the valves on the truck discharge line.
- Stand by until the truck cargo is completely unloaded.
- If compressed air is used, allow the air to flush out the lines to the storage tank and then cut off the air supply.
- When a pump is used, flush out the unloading line before disconnecting the hose. If water is available, a small quantity can be added into the truck while the pump is running to flush out the line. Air or water can be used to flush the caustic soda in the line into the storage tank or back to the truck. If no water is available for flushing out lines, exercise great caution when lines are disconnected.

# Unloading Liquid Caustic Soda in Tank Trucks

- Close the valve on the storage fill line.
- Close all valves on the tank truck.
- In some installations the customer's fill line is fitted with a drain to be used instead of flushing the line before the hose is disconnected.
- Disconnect the hose with caution and discharge any caustic soda remaining in the hose to a suitable container.
- Unload caustic soda in an area with adequate safeguards for spill control. No caustic soda should be spilled, but in the event a small amount is spilled, hose down the area with water. Clean up all spills and dispose in accordance with federal, state and local regulations.

## FACILITY EQUIPMENT

Typical installations of storage vessels for receipt of truck shipments are similar to those shown in Figures 2 and 3 for rail car deliveries.

A storage tank with a minimum capacity of 1.5 tank cars is recommended.

A fill line to the top of the storage is strongly recommended. If a bottom fill line is used, the truck driver must be informed.

A permanent fill line in close proximity to the tank truck unloading area is required.

A 2-inch or larger fill line is recommended.

A 3/4-inch valve connection is recommended on the fill line for use in flushing out the line with air, water, or steam. It can be used as a drain.

Cap or close the end of the fill line when not in use.

A source of running water for use during unloading operations is required. A safety shower and eye-wash fountain are recommended.

## GENERAL CONSIDERATIONS

Caustic soda is a corrosive chemical which is normally handled in either steel, nickel, nickel alloys or certain types of plastic equipment. The specific material will depend on the conditions under which the material is being used. Temperature, solution concentration, location and safety considerations are all important factors in equipment selection.

## MATERIALS OF CONSTRUCTION

The most common construction materials for handling and storing caustic soda solutions are black iron and mild steel; however, liquid caustic soda will attack these metals at elevated temperatures. The ideal storage temperature for caustic soda solutions is 80 to 100°F. In steel systems, temperatures above 120°F will cause accelerated corrosion and iron contamination of the caustic (above 120°F, cracking can occur if concentrated caustic is processed in steel equipment that has not been stress relieved.) Where iron contamination or corrosion is unacceptable, epoxy lined steel, 316L and 304L stainless steels are recommended. 316L and 304L stainless is acceptable to 200°F. At temperatures above 200°F, nickel is typically used but Monel®, Inconel®, or Hastelloy® can also be used. Consult with the epoxy supplier about the working temperature range of a particular epoxy lining.

Plastics, such as polyethylene, polypropylene, PVC, and CPVC, are chemically suitable with caustic soda. They can be used to prevent iron contamination if maximum temperatures for each material are not exceeded. The manufacturer of the tank, drum, piping or equipment in question should be contacted to

determine the exact limitations of the specific plastic. Aluminum, copper, zinc, lead and their alloys (e.g., brass and bronze) are NOT suitable. Caustic soda readily attacks these materials.

## STORAGE TANKS

Tanks can be either vertical or horizontal. They are usually fabricated from at least 1/4-inch steel plate. A 1/8-inch corrosion allowance should be included in the design. If iron contamination is a problem, tanks can be fabricated from 304L or 316L stainless steel. If the tanks are large, it's usually more economical to fabricate a steel tank and line it with an epoxy coating. Plastic tanks are usually fabricated from polypropylene or FRP (Since caustic can attack glass reinforcement fibers of improperly constructed FRP tanks, care must be taken to ensure that the FRP tanks are built with the proper reinforcing materials, resins, catalysts, curing procedures and corrosion barriers).

The product draw-off line should be at least 4 inches above the bottom of the tank and the drain connection should be at the lowest point in the tank. This will facilitate drainage during periodic cleaning of the tank. Most tanks have a level transmitter for measuring liquid level.

Where heating is required, an external heat exchanger with a circulating pump or internal steam heating coils are most commonly employed. The preferred materials for the coils are nickel, Monel®, or Inconel®. Despite this, stainless steel is most commonly used because of cost considerations.(At

high temperatures, stainless steel may crack). If it is necessary to insulate the storage tank, a two-inch layer of polyurethane foam or cellular glass should be adequate.

Proper design of a storage system will include adequate containment in case of tank failure. State and local regulatory authorities should always be consulted during the design phase of construction.

## TANK CLEANING AND PASSIVATION

Tank cleaning is dependent on the product stored in it previously. A tank that previously contained caustic soda requires scale removal, wall thickness testing, rinsing, passivation, floor cleaning, and immediate filling. A tank previously containing another product requires cleaning with an appropriate solvent or soap, as well as the other steps mentioned above.

Scale removal is accomplished by blasting the walls with an abrasive such as sand or pecan shells. Abrasives containing high percentages of metals are not recommended.

The wall thickness of the tank should be measured to ensure that the tank has structural integrity for the density of the product and the height of product in the tank.

Passivation requires permeation of the steel tank walls with caustic soda. This is usually accomplished by spraying the cleaned walls with a hot solution of caustic soda. Temperatures of 100 - 140°F and solutions of 5 - 20% are recommended. While this is more of an art than a science, a standard rec-

ommendation would be spraying the walls for 2-4 hours with 10% solution at 140°F. The larger the tank the longer it should be sprayed to complete the passivation. Utilizing a hotter and stronger solutions will require less time for passivation. One way to achieve the solution heat necessary is to dilute 50% caustic soda to 20%. The heat of dilution will cause the caustic soda temperature to rise. Additional heat may be necessary to achieve optimal solution temperatures. The coating of the tank walls is best accomplished with an elliptical sprayer. If this type of sprayer is not available, **the spraying may be done manually with extreme caution taken to protect the operator.**

After passivation, the tank bottom must be cleaned out as well as possible. The quality of the initial product stored in the tank will depend greatly upon the extent to which the tank bottom is cleaned of scale abrasive compound. If an elliptical sprayer is used for the cleaning, a squeegee will need to be used to clean the tank bottom. If manual spraying is used for cleaning, the sprayer can be used to push the scale and abrasive toward the sump followed up by use of a

squeegee.

After cleaning, the tank should be filled with caustic soda as soon as possible. This will prevent the tank walls from losing their passivation. If the tank cleaning is not completely successful, it may be necessary to filter the initial product from the tank to keep it free from particulate matter. This would require a 5-10 micron filter media housed in a unit that would be acceptable with the temperature, pressure, and chemical.

## PIPING AND VALVES

Pipelines are usually at least two inches in diameter and constructed of Schedule 40 black iron or mild steel with welded or flanged joints. Where disconnects are necessary, flanged joints are preferred to facilitate maintenance. A safety shield of wrap-around polypropylene is recommended for all flanged joints. This will protect against spraying in case a gasket leaks.

Proper pipeline design includes an adequate pitch to permit complete draining. Avoid any loops or pockets. Lines should also include water or air connections for purging after use.

Where slight iron contamination is unacceptable, CPVC, polypropylene, polypropylene-lined steel, and Teflon® lined steel pipe are suitable materials. Pay special attention to suitable operating tempera-

tures and pressures with these materials.

Ductile iron, cast steel, stainless steel, Alloy 20, and Teflon®-lined quarter-turn plug or ball valves are recommended for caustic soda service. Various other types of valves can also be used; however, keep in mind that less elaborate fittings provide better reliability in this service.

## PUMPS

Centrifugal pump of stainless steel or Alloy 20 construction, with either double mechanical seals or a deep packing gland, is recommended. Packing material should be Teflon® impregnated, caustic resistant fibers, or equivalent. To avoid seals altogether, magnetically coupled pumps could be used.

Pump location should receive careful consideration. For ease of operation, keep the suction lines as short as possible. A recirculating line will help prevent excess wear on the pump and, in many cases, can assist in controlling flow rates.

## METERS

Caustic soda solutions can be metered through standard rotameters having non-glass tubes and nickel or stainless steel floats. Magnetic, coriolis or orifice-type meters are preferred for strong, hot solutions. They should be made of corrosion resistant materials such as stainless steel, alloy 20, monel or nickel.

Figure 6: Typical Storage Tank Installation

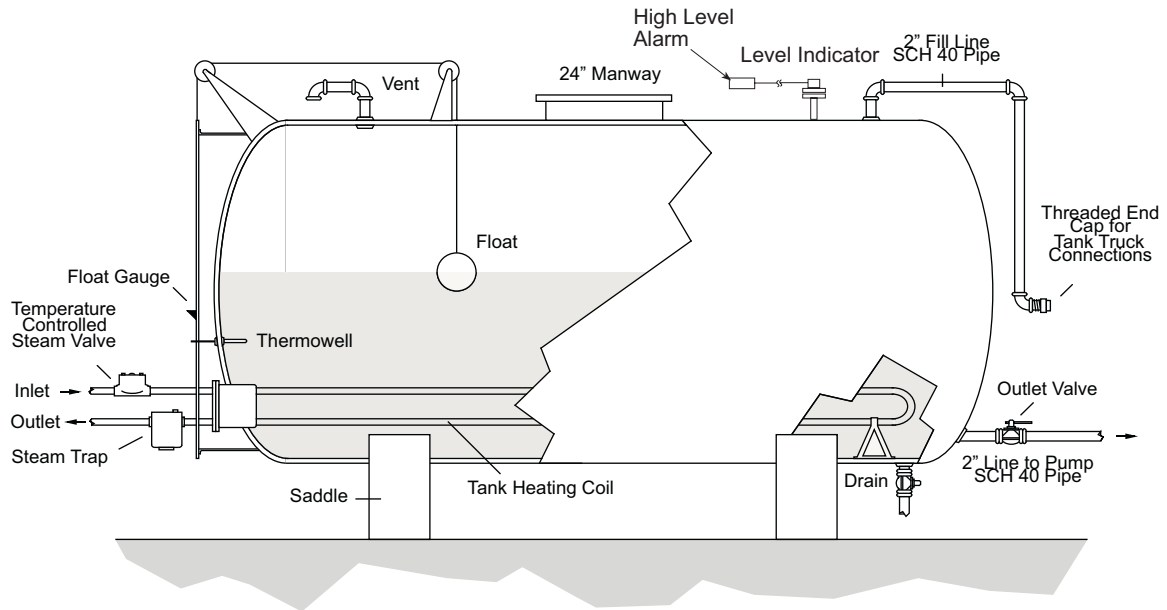

**\*NOTE: All tanks should be located within a diked area.**

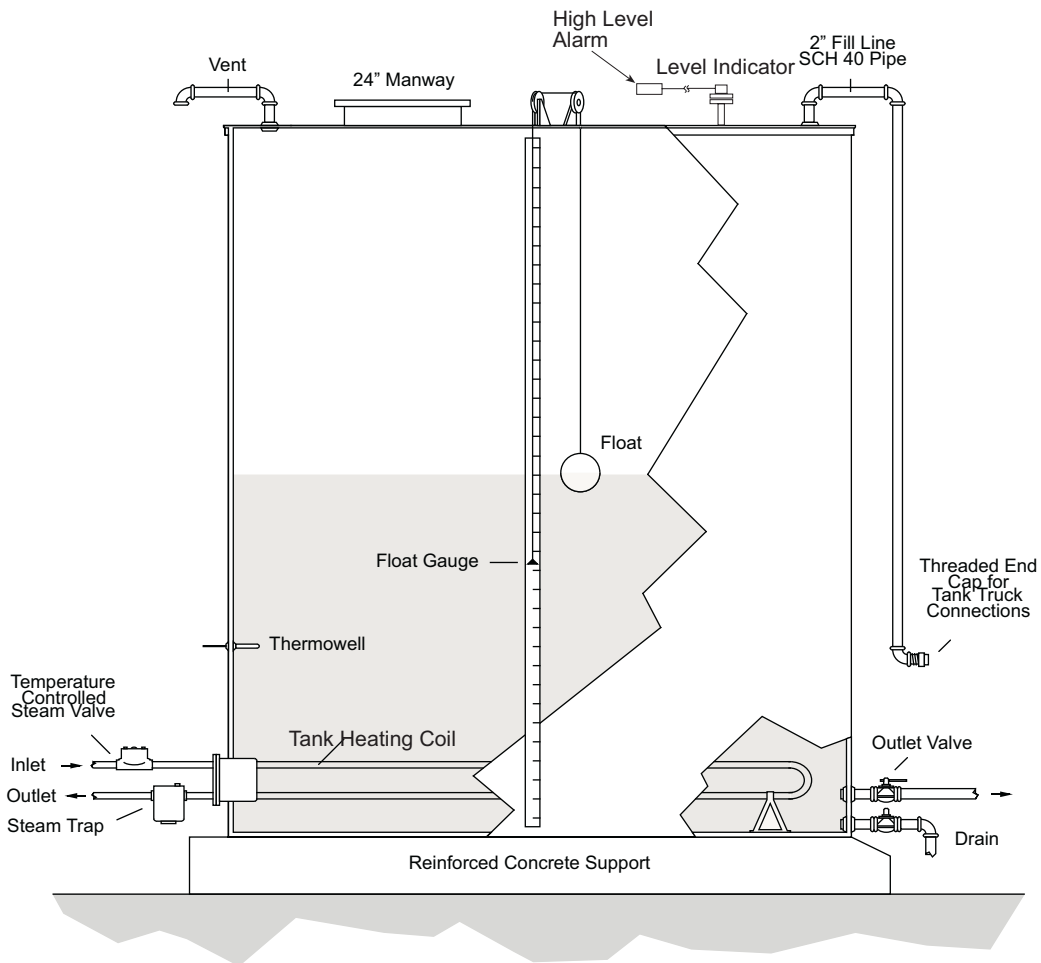



# Technical Data

**Table 1 Density and Caustic Soda Content of Rayon/Membrane Grade  
Caustic Soda Solutions at 60°F**

WT% NaOH	% Na <sub>2</sub> O	SPECIFIC GRAVITY	DEGREES BAUMÉ [AM STD]	NaOH G/L	NaOH LB/GAL	SOLUTION LB/GAL	TOTAL WT NaOH LB/CU FT	TOTAL WT SOLUTION LB/CU FT
1.0	0.775	1.0120	1.706	10.118	0.084	8.437	0.631	63.113
2.0	1.550	1.0230	3.259	20.457	0.171	8.529	1.277	63.804
3.0	2.325	1.0342	4.782	31.019	0.259	8.622	1.935	64.497
4.0	3.100	1.0453	6.274	41.803	0.349	8.715	2.608	65.191
5.0	3.874	1.0564	7.736	52.811	0.440	8.807	3.295	65.885
6.0	4.649	1.0676	9.170	64.042	0.534	8.900	3.995	66.581
7.0	5.424	1.0787	10.580	75.496	0.630	8.993	4.710	67.277
8.0	6.199	1.0899	11.960	87.174	0.727	9.087	5.438	67.973
9.0	6.974	1.1010	13.310	99.076	0.826	9.180	6.181	68.670
10.0	7.748	1.1122	14.630	111.210	0.927	9.273	6.937	69.367
11.0	8.523	1.1234	15.930	123.550	1.031	9.366	7.707	70.063
12.0	9.298	1.1345	17.200	136.130	1.136	9.459	8.492	70.759
13.0	10.080	1.1457	18.440	148.920	1.242	9.552	9.290	71.455
14.0	10.850	1.1569	19.660	161.930	1.351	9.645	10.110	72.150
15.0	11.630	1.1680	20.850	175.170	1.461	9.738	10.930	72.845
16.0	12.400	1.1791	22.030	188.630	1.573	9.830	11.770	73.539
17.0	13.180	1.1902	23.170	202.300	1.687	9.923	12.620	74.231
18.0	13.950	1.2013	24.300	216.200	1.803	10.020	13.490	74.922
19.0	14.730	1.2124	25.400	230.310	1.921	10.110	14.370	75.612
20.0	15.500	1.2234	26.480	244.640	2.040	10.200	15.260	76.300
21.0	16.280	1.2344	27.530	259.180	2.162	10.300	16.170	76.987
22.0	17.050	1.2454	28.570	273.940	2.285	10.390	17.090	77.672
23.0	17.830	1.2563	29.590	288.910	2.409	10.480	18.030	78.355
24.0	18.600	1.2672	30.580	304.090	2.536	10.570	18.970	79.035
25.0	19.370	1.2781	31.550	319.470	2.664	10.660	19.930	79.713
26.0	20.150	1.2889	32.510	335.070	2.794	10.750	20.910	80.389
27.0	20.920	1.2997	33.440	350.870	2.926	10.840	21.890	81.062
28.0	21.700	1.3105	34.350	366.870	3.060	10.930	22.890	81.731
29.0	22.470	1.3212	35.250	383.070	3.195	11.020	23.900	82.398
30.0	23.250	1.3317	36.120	399.450	3.331	11.110	24.920	83.057
31.0	24.020	1.3424	36.980	416.070	3.470	11.200	25.960	83.722
32.0	24.800	1.3529	37.830	432.860	3.610	11.280	27.010	84.379
33.0	25.570	1.3634	38.650	449.850	3.751	11.370	28.070	85.033
34.0	26.350	1.3738	39.450	467.010	3.895	11.460	29.140	85.681
35.0	27.120	1.3842	40.240	484.370	4.039	11.540	30.220	86.327
36.0	27.900	1.3944	41.020	501.910	4.186	11.630	31.310	86.968
37.0	28.670	1.4046	41.770	519.630	4.333	11.720	32.420	87.605
38.0	29.450	1.4148	42.510	537.520	4.482	11.800	33.530	88.237
39.0	30.220	1.4248	43.230	555.590	4.633	11.880	34.660	88.864
40.0	31.000	1.4348	43.940	573.830	4.785	11.970	35.800	89.487
41.0	31.770	1.4447	44.640	592.240	4.939	12.050	36.950	90.105
42.0	32.550	1.4545	45.310	610.810	5.094	12.130	38.110	90.717
43.0	33.320	1.4643	45.980	629.530	5.250	12.210	39.270	91.324
44.0	34.100	1.4739	46.630	648.420	5.407	12.290	40.450	91.926
45.0	34.870	1.4835	47.260	667.450	5.566	12.370	41.640	92.522
46.0	35.650	1.4930	47.880	686.640	5.726	12.450	42.840	93.113
47.0	36.420	1.5023	48.480	705.970	5.887	12.530	44.040	93.697
48.0	37.200	1.5116	49.080	725.440	6.049	12.610	45.260	94.275
49.0	37.970	1.5208	49.650	745.040	6.213	12.680	46.480	94.847
<b>50.0</b>	<b>38.740</b>	<b>1.5298</b>	<b>50.220</b>	<b>764.780</b>	<b>6.377</b>	<b>12.760</b>	<b>47.710</b>	<b>95.412</b>
51.0	39.520	1.5388	50.770	784.640	6.543	12.830	48.950	95.971
52.0	40.290	1.5476	51.310	804.630	6.710	12.910	50.200	96.523

# Technical Data

**Table 2 Density and Caustic Soda Content of Diaphragm Grade  
Caustic Soda Solutions at 60°F**

WT% NaOH	% Na <sub>2</sub> O	% NaCl	SPECIFIC GRAVITY	DEGREES BAUMÉ [AM STD]	NaOH G/L	NaOH LB/GAL	TOTAL WT SOLUTION LB/GAL	LB/CU FT	TOTAL WT SOLUTION LB/CU FT
1.0	0.775	0.020	1.0121	1.726	10.120	0.084	8.438	0.631	63.122
2.0	1.550	0.040	1.0233	3.300	20.463	0.171	8.532	1.277	63.823
3.0	2.325	0.060	1.0346	4.842	31.032	0.259	8.626	1.936	64.525
4.0	3.100	0.080	1.0459	6.351	41.827	0.349	8.719	2.610	65.227
5.0	3.874	0.100	1.0571	7.829	52.846	0.441	8.813	3.297	65.930
6.0	4.649	0.120	1.0684	9.282	64.095	0.535	8.908	3.999	66.636
7.0	5.424	0.140	1.0797	10.710	75.568	0.630	9.002	4.714	67.341
8.0	6.199	0.160	1.0911	12.100	87.269	0.728	9.096	5.444	68.047
9.0	6.974	0.180	1.1024	13.460	99.195	0.827	9.191	6.188	68.752
10.0	7.748	0.200	1.1137	14.800	111.350	0.928	9.285	6.946	69.458
11.0	8.523	0.220	1.1250	16.110	123.730	1.032	9.379	7.718	70.164
12.0	9.298	0.240	1.1363	17.390	136.340	1.137	9.474	8.505	70.870
13.0	10.080	0.260	1.1476	18.650	149.170	1.244	9.568	9.305	71.575
14.0	10.850	0.280	1.1589	19.880	162.220	1.353	9.662	10.120	72.279
15.0	11.630	0.300	1.1702	21.090	175.500	1.464	9.756	10.950	72.983
16.0	12.400	0.320	1.1815	22.270	189.000	1.576	9.850	11.790	73.685
17.0	13.180	0.340	1.1927	23.430	202.730	1.691	9.944	12.650	74.387
18.0	13.950	0.360	1.2040	24.560	216.680	1.807	10.040	13.520	75.088
19.0	14.730	0.380	1.2152	25.670	230.840	1.925	10.140	14.400	75.787
20.0	15.500	0.400	1.2263	26.760	245.230	2.045	10.230	15.300	76.485
21.0	16.280	0.420	1.2375	27.830	259.830	2.167	10.320	16.210	77.180
22.0	17.050	0.440	1.2486	28.870	274.650	2.291	10.410	17.140	77.874
23.0	17.830	0.460	1.2597	29.900	289.690	2.416	10.510	18.080	78.566
24.0	18.600	0.480	1.2708	30.900	304.930	2.543	10.600	19.030	79.255
25.0	19.370	0.500	1.2818	31.880	320.400	2.672	10.690	19.990	79.943
26.0	20.150	0.520	1.2928	32.840	336.070	2.803	10.780	20.970	80.628
27.0	20.920	0.540	1.3037	33.780	351.940	2.935	10.870	21.960	81.310
28.0	21.700	0.560	1.3146	34.700	368.020	3.069	10.960	22.960	81.988
29.0	22.470	0.580	1.3254	35.600	384.310	3.205	11.050	23.980	82.665
30.0	23.250	0.600	1.3362	36.490	400.800	3.342	11.140	25.010	83.338
31.0	24.020	0.620	1.3470	37.350	417.490	3.482	11.230	26.050	84.007
32.0	24.800	0.640	1.3576	38.200	434.370	3.622	11.320	27.100	84.673
33.0	25.570	0.660	1.3683	39.030	451.450	3.765	11.410	28.170	85.335
34.0	26.350	0.680	1.3788	39.840	468.720	3.909	11.500	29.240	85.994
35.0	27.120	0.700	1.3893	40.630	486.170	4.054	11.590	30.330	86.648
36.0	27.900	0.720	1.3997	41.410	503.820	4.201	11.670	31.430	87.299
37.0	28.670	0.740	1.4101	42.170	521.640	4.350	11.760	32.540	87.944
38.0	29.450	0.760	1.4204	42.920	539.650	4.500	11.850	33.670	88.586
39.0	30.220	0.780	1.4306	43.640	557.830	4.652	11.930	34.800	89.223
40.0	31.000	0.800	1.4407	44.360	576.190	4.805	12.020	35.950	89.854
41.0	31.770	0.820	1.4508	45.050	594.710	4.959	12.100	37.100	90.481
42.0	32.550	0.840	1.4607	45.740	613.400	5.115	12.180	38.270	91.103
43.0	33.320	0.860	1.4706	46.400	632.260	5.272	12.270	39.440	91.720
44.0	34.100	0.880	1.4804	47.060	651.270	5.431	12.350	40.630	92.330
45.0	34.870	0.900	1.4901	47.690	670.440	5.591	12.430	41.830	92.935
46.0	35.650	0.920	1.4997	48.320	689.760	5.752	12.510	43.030	93.535
47.0	36.420	0.940	1.5092	48.930	709.220	5.914	12.590	44.250	94.129
48.0	37.200	0.960	1.5187	49.520	728.830	6.078	12.670	45.470	94.716
49.0	37.970	0.980	1.5280	50.100	748.580	6.242	12.740	46.700	95.297
<b>50.0</b>	<b>38.740</b>	<b>1.000</b>	<b>1.5372</b>	<b>50.670</b>	<b>768.460</b>	<b>6.408</b>	<b>12.820</b>	<b>47.940</b>	<b>95.872</b>
51.0	39.520	1.000	1.5506	51.490	790.690	6.594	12.930	49.330	96.711
52.0	40.290	1.000	1.5604	52.070	811.250	6.765	13.010	50.610	97.317

# Technical Data

**Table 3 Specific Heats of Caustic Soda Solutions in BTU's per Pound**

PERCENT CAUSTIC	TEMPERATURE °F															
	32	40	50	60	80	100	120	140	160	180	200	220	240	260	280	300
0	1.004	1.003	1.001	0.999	0.998	0.997	0.998	0.999	1.000	1.002	1.004	-	-	-	-	-
2	0.965	0.967	0.968	0.969	0.972	0.974	0.977	0.978	0.980	0.983	0.986	-	-	-	-	-
4	0.936	0.940	0.943	0.946	0.951	0.954	0.957	0.960	0.962	0.965	0.966	-	-	-	-	-
6	0.914	0.920	0.924	0.928	0.933	0.938	0.941	0.944	0.946	0.948	0.950	-	-	-	-	-
8	0.897	0.902	0.907	0.911	0.918	0.923	0.927	0.930	0.932	0.934	0.936	-	-	-	-	-
10	0.882	0.888	0.893	0.897	0.905	0.911	0.916	0.918	0.920	0.922	0.923	-	-	-	-	-
12	0.870	0.877	0.883	0.887	0.894	0.901	0.906	0.909	0.911	0.912	0.913	-	-	-	-	-
14	0.861	0.868	0.874	0.879	0.886	0.892	0.897	0.901	0.903	0.903	0.904	-	-	-	-	-
16	0.853	0.860	0.866	0.871	0.880	0.886	0.891	0.894	0.896	0.897	0.897	-	-	-	-	-
18	0.847	0.854	0.860	0.865	0.873	0.880	0.885	0.888	0.890	0.891	0.891	-	-	-	-	-
20	0.842	0.848	0.854	0.859	0.868	0.875	0.880	0.884	0.886	0.886	0.887	-	-	-	-	-
22	0.837	0.844	0.849	0.854	0.863	0.870	0.876	0.880	0.882	0.882	0.883	-	-	-	-	-
24	-	0.839	0.844	0.849	0.858	0.866	0.873	0.877	0.879	0.879	0.880	-	-	-	-	-
26	-	0.835	0.840	0.845	0.854	0.863	0.869	0.874	0.875	0.876	0.876	-	-	-	-	-
28	-	0.830	0.836	0.841	0.850	0.859	0.866	0.870	0.872	0.872	0.873	-	-	-	-	-
30	-	0.826	0.832	0.837	0.846	0.855	0.862	0.866	0.868	0.869	0.869	-	-	-	-	-
32	-	0.822	0.828	0.833	0.842	0.850	0.857	0.862	0.863	0.864	0.864	-	-	-	-	-
34	-	-	0.823	0.828	0.837	0.845	0.852	0.856	0.857	0.858	0.858	-	-	-	-	-
36	-	-	0.819	0.824	0.832	0.840	0.845	0.849	0.850	0.851	0.851	-	-	-	-	-
38	-	-	0.816	0.820	0.827	0.833	0.837	0.841	0.842	0.842	0.843	-	-	-	-	-
40	-	-	0.812	0.815	0.821	0.826	0.829	0.831	0.832	0.832	0.832	-	-	-	-	-
42	-	-	0.807	0.809	0.813	0.816	0.819	0.819	0.820	0.820	0.820	-	-	-	-	-
44	-	-	-	0.802	0.804	0.806	0.807	0.807	0.807	0.806	0.804	-	-	-	-	-
46	-	-	-	0.793	0.794	0.795	0.794	0.794	0.793	0.791	0.789	-	-	-	-	-
48	-	-	-	-	0.783	0.782	0.781	0.780	0.779	0.777	0.776	-	-	-	-	-
50	-	-	-	-	0.771	0.769	0.768	0.767	0.765	0.765	0.764	0.763	0.762	0.762	0.761	0.761
52	-	-	-	-	0.759	0.757	0.756	0.754	0.753	0.752	0.751	0.749	0.748	0.747	0.746	0.745
54	-	-	-	-	0.746	0.744	0.741	0.739	0.739	0.738	0.737	0.735	0.733	0.731	0.730	0.728
56	-	-	-	-	0.733	0.730	0.728	0.726	0.724	0.723	0.722	0.721	0.719	0.717	0.715	0.713
58	-	-	-	-	-	0.719	0.717	0.715	0.713	0.711	0.709	0.707	0.705	0.703	0.702	0.700
60	-	-	-	-	-	0.706	0.705	0.703	0.701	0.699	0.697	0.696	0.693	0.691	0.690	0.688
62	-	-	-	-	-	-	0.694	0.692	0.690	0.688	0.687	0.685	0.683	0.681	0.679	0.677
64	-	-	-	-	-	-	0.684	0.682	0.681	0.679	0.677	0.675	0.673	0.671	0.670	0.668
66	-	-	-	-	-	-	0.675	0.673	0.671	0.669	0.668	0.666	0.664	0.662	0.660	0.658
68	-	-	-	-	-	-	-	0.663	0.662	0.660	0.658	0.656	0.655	0.653	0.651	0.649
70	-	-	-	-	-	-	-	0.655	0.653	0.651	0.649	0.647	0.646	0.644	0.642	0.640
72	-	-	-	-	-	-	-	-	0.645	0.643	0.641	0.639	0.637	0.635	0.634	0.632
73	-	-	-	-	-	-	-	-	-	0.639	0.637	0.635	0.633	0.631	0.630	0.628
74	-	-	-	-	-	-	-	-	-	0.635	0.633	0.631	0.629	0.628	0.626	0.624
74.5	-	-	-	-	-	-	-	-	-	0.633	0.631	0.629	0.627	0.626	0.624	0.622
76	-	-	-	-	-	-	-	-	-	0.628	0.627	0.625	0.623	0.621	0.619	0.617
78	-	-	-	-	-	-	-	-	-	-	0.620	0.618	0.616	0.615	0.613	0.611

## Properties of Anhydrous Caustic Soda

**Table 4  
Miscellaneous Properties**

Property	Value
Chemical Formula	NaOH
Molecular Weight	40.00
Freezing or melting point	318°C or 604°F
Boiling point	1388°C or 2530°F at 760 mm Hg pressure
Specific heat	0.353 cal/gm/°C at 20°C or 0.353 BTU/lb/°F at 68°F
Free energy of formation	-90,762 cal/mol at 25°C, 760 mm Hg pressure
Refractive index for light wavelength of 5894 A	N = 1.433 at 320°C N = 1.421 at 420°C
Latent heat of fusion	40.0 cal/gm or 72.0 BTU/lb
Lattice energy	176.2 kg-cal/mol
Entropy	12.43 kg-cal/mol/°K at 25°C, 760 mm Hg pressure
Heat of formation Na+½O <sub>2</sub> +½H <sub>2</sub> =NaOH	101.723 kcal/mol

**Table 5  
Specific Gravity of Solid Caustic Soda**

Temp.°C	20	299.6	320	350	400	450
Specific gravity	2.130	2.08	1.786	1.771	1.746	1.722

Note: The average bulk density of flake Caustic Soda is about 60 pounds per cubic foot. This value varies with the packing conditions and flake characteristics.

**Table 6  
Enthalpy of Anhydrous Caustic Soda  
(Above 32°F base temperature)**

Solid NaOH		Molten NaOH	
Temp.°F	BTU/lb	Temp.°F	BTU/lb
32	0.00	605.1	356.06
50	5.57	650	381.47
100	21.71	700	408.94
150	38.82	750	435.59
200	56.91	800	461.28
250	75.98	850	486.48
300	96.01	900	510.70
350	117.03	950	534.12
400	139.02	1000	556.72
450	161.98	1050	578.52
500	185.92	1100	599.51
550	210.83	1150	619.68
600	281.27	1300	675.35
605.1	283.97	1350	692.29

**Table 7  
Viscosity of Molten Caustic Soda**

Temp. °C	350	400	450	500	550
Viscosity, centipoise	4.0	2.8	2.2	1.8	1.5

**Table 8  
Vapor Pressure of Molten Caustic Soda**

Temp.°C	1000	1050	1100	1200	1300	1388
Vapor Pressure in mm Hg	41	66	103	225	447	760

## Properties of Caustic Soda Solutions

**Table 9**  
**Coefficient of Expansion of  
Caustic Soda Solutions**

The coefficient of expansion is the volume change per unit change in temperature. It may be derived from data on the change of density with temperature according to the following formula:

$$d = 1.0200 + 0.01050X - (0.0005 + 0.0000049X)t$$

Note: "d" is the density in g/cc; "X" is the concentration in percent by weight of NaOH; and "t" is the temperature in °C. The formula is limited to concentrations from 10% to 70% NaOH and to temperatures from 15°C to 70°C.

**Table 10**  
**Compressibility of  
Caustic Soda Solutions**

<u>Moles H<sub>2</sub>O/ Mole NaOH</u>	<u>Density</u>	<u>B x 10<sup>6</sup></u>
25.01	1.08670	31.23
50.09	1.04391	36.15
100.15	1.02114	39.12

Note: The compressibility coefficient B is expressed as compressibility per cc per megabar at 25°C. Data is valid between 100-300 megabars.

**Table 11**  
**Heat of Solution of Caustic Soda  
Heat Liberated**

<u>% NaOH</u>	<u>Moles H<sub>2</sub>O/ Mole NaOH</u>	<u>BTU/lb. NaOH</u>	<u>BTU/lb. Solution</u>	<u>cal/g NaOH</u>
0.44	500	455.8	2.0	253.2
0.55	400	456.0	2.5	253.3
1.10	200	456.6	5.0	253.7
2.17	100	458.3	9.9	254.6
4.26	50	462.0	19.7	256.7
8.16	25	462.6	37.7	257.0
14.14	13.5	470.1	66.5	261.2
19.80	9	462.2	91.5	256.8
24.10	7	457.9	110.4	254.4
30.77	5	419.2	129.0	232.9
42.55	3	323.5	137.6	179.7

**Table 12**  
**Heat of Dilution of  
Caustic Soda Solutions**

<u>Wt.% NaOH</u>	<u>BTU/lb NaOH</u>	<u>BTU/lb Solution</u>
0	0	0
2	+ 1.18	+ 0.0236
4	- 2.04	- 0.0808
6	- 4.78	- 0.287
8	- 7.15	- 0.572
10	- 8.60	- 0.860
12	- 9.13	- 1.09
14	- 8.65	- 1.21
16	- 7.34	- 1.17
18	- 4.99	- 0.897
20	- 1.50	- 0.301
22	+ 3.28	+ 0.721
24	9.47	2.27
26	17.14	4.46
28	26.43	7.40
30	37.34	11.20
32	49.97	15.99
34	64.05	21.76
36	79.63	28.66
38	96.50	36.67
40	114.2	45.69
42	132.8	55.78
44	151.7	66.76
46	170.7	78.52
48	189.7	91.04

Note: Enthalpy of solutions at 68°F relative to infinitely dilute solutions.

Table 13

**Index of Refraction of  
Caustic Soda Solutions**

<u>Temp. °C</u>	<u>NaOH g/L</u>	<u>Refractive Index</u>
20°C	0	1.33302
	7.88	1.33517
	13.12	1.33660
	35.44	1.34236
	55.12	1.34714
	98.48	1.35685
	131.52	1.36364
25°C	0	1.33251
	7.88	1.33467
	13.08	1.33605
	35.4	1.34174
	55.04	1.34644
	98.28	1.35603
	131.2	1.36279
30°C	0	1.33196
	7.88	1.33411
	13.04	1.33551
	35.36	1.34108
	54.96	1.34572
	98.08	1.35530
	130.92	1.36204

Table 14

**Hydrogen Ion Concentrations of  
Caustic Soda Solutions at 25°C**

<u>% NaOH</u>	<u>NaOH Moles/L</u>	<u>pH</u>
7.40	2.0	14.0
3.83	1.0	13.8
1.96	0.5	13.6
0.39	0.1	12.9
0.20	0.05	12.6
0.04	0.01	12.0

Due to the difficulty of obtaining accurate pH readings at values above 12, pH is not a valid method to determine concentration.

### Graph 1 Boiling and Solidifying Temperatures of Aqueous Caustic Soda Solutions

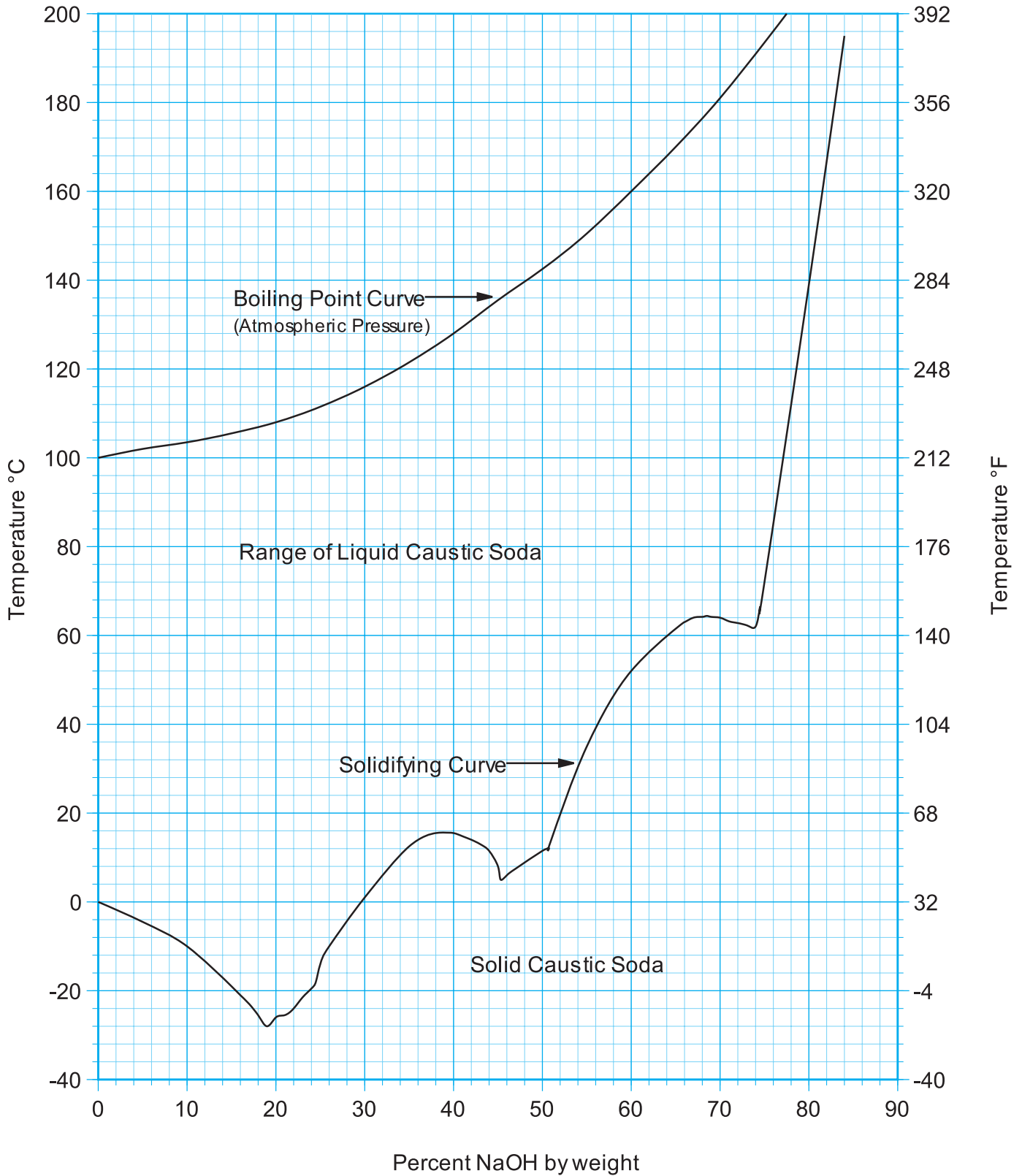

## Graph 2 Specific Gravity of Aqueous Caustic Soda Solutions

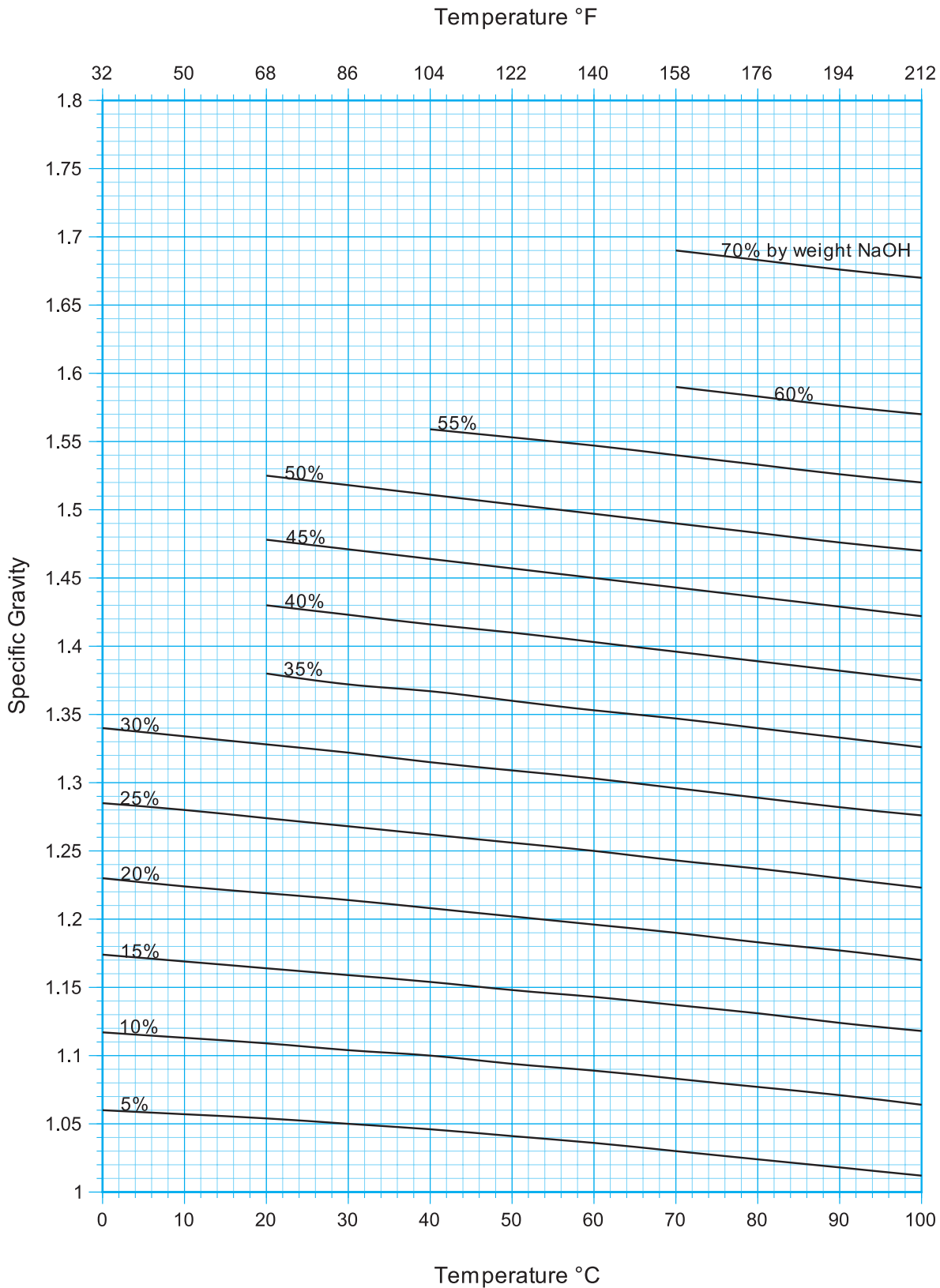



### Graph 3 Viscosity of Aqueous Caustic Soda Solutions

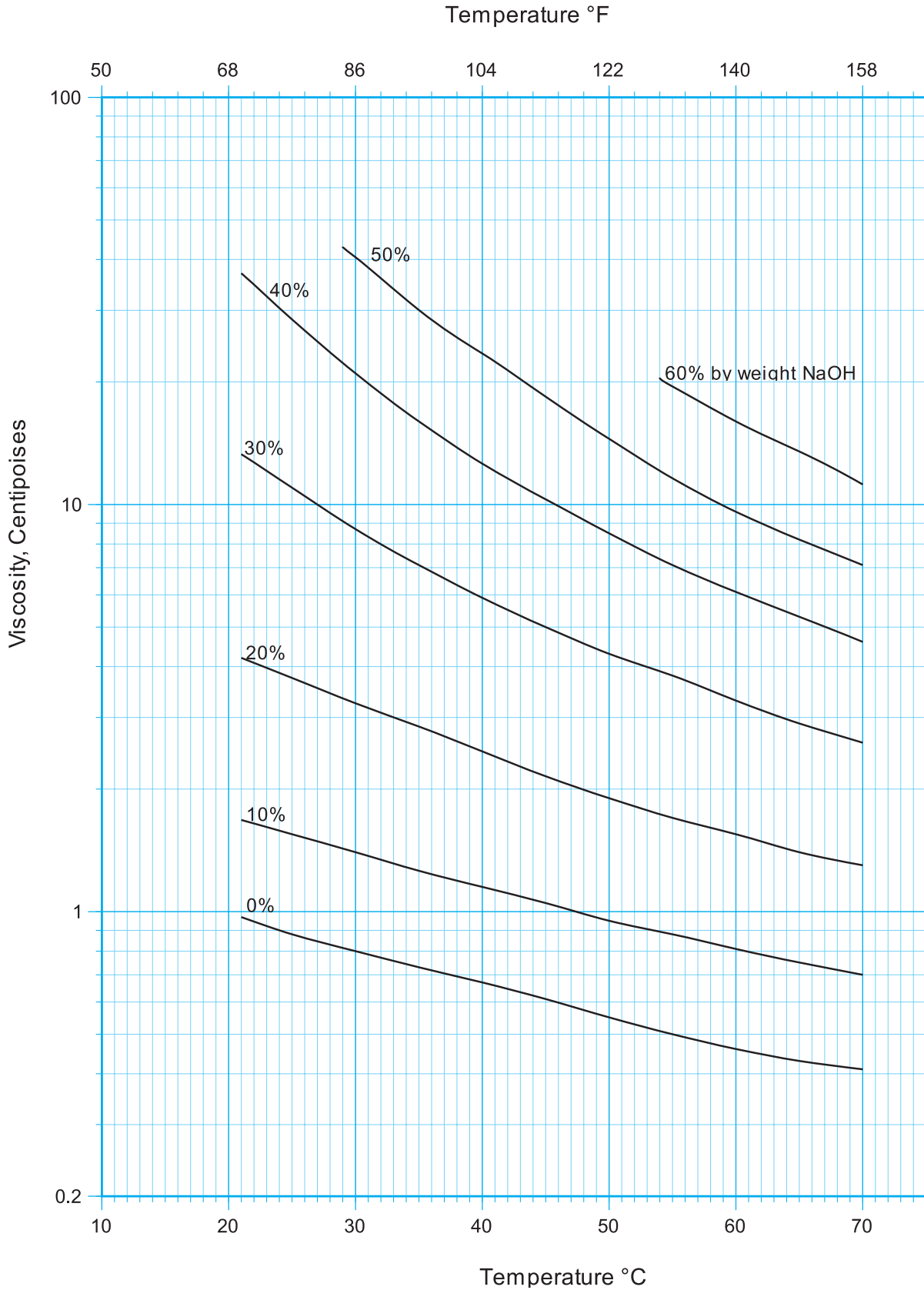

### Graph 4 Vapor Pressures of Aqueous Caustic Soda Solutions

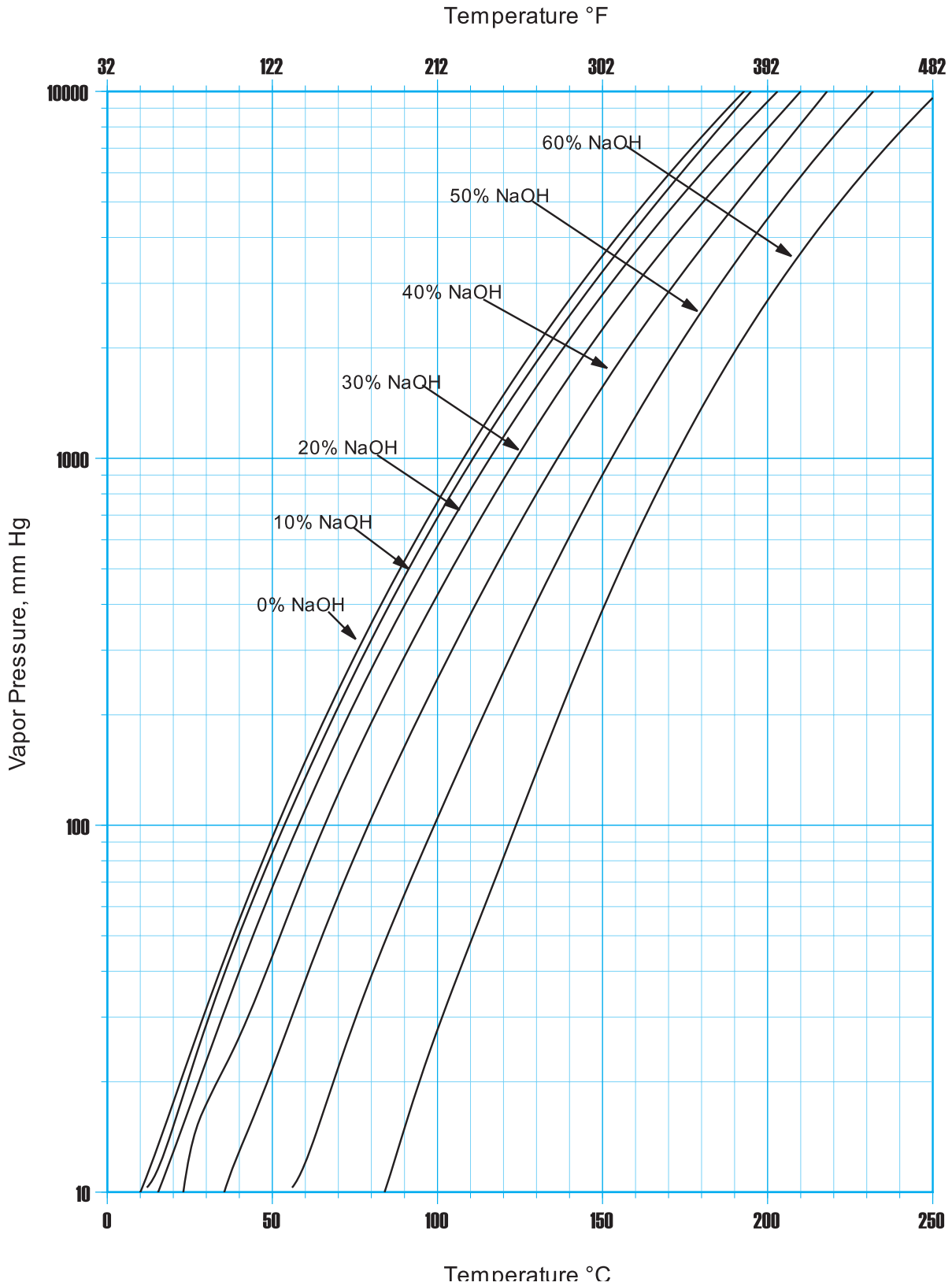

### Graph 5 Approximate Resultant Temperature When Diluting Caustic Soda

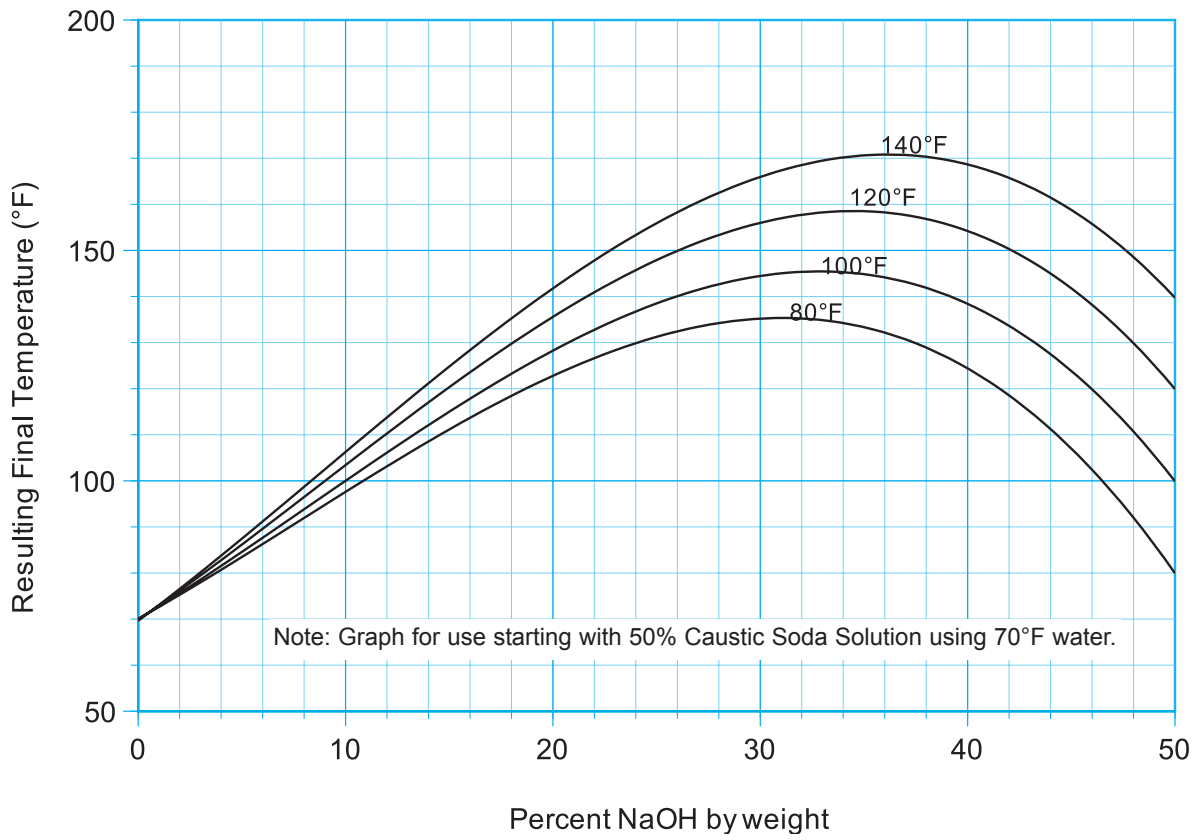

### Graph 6 Relative Enthalpy of Aqueous Caustic Soda Solutions

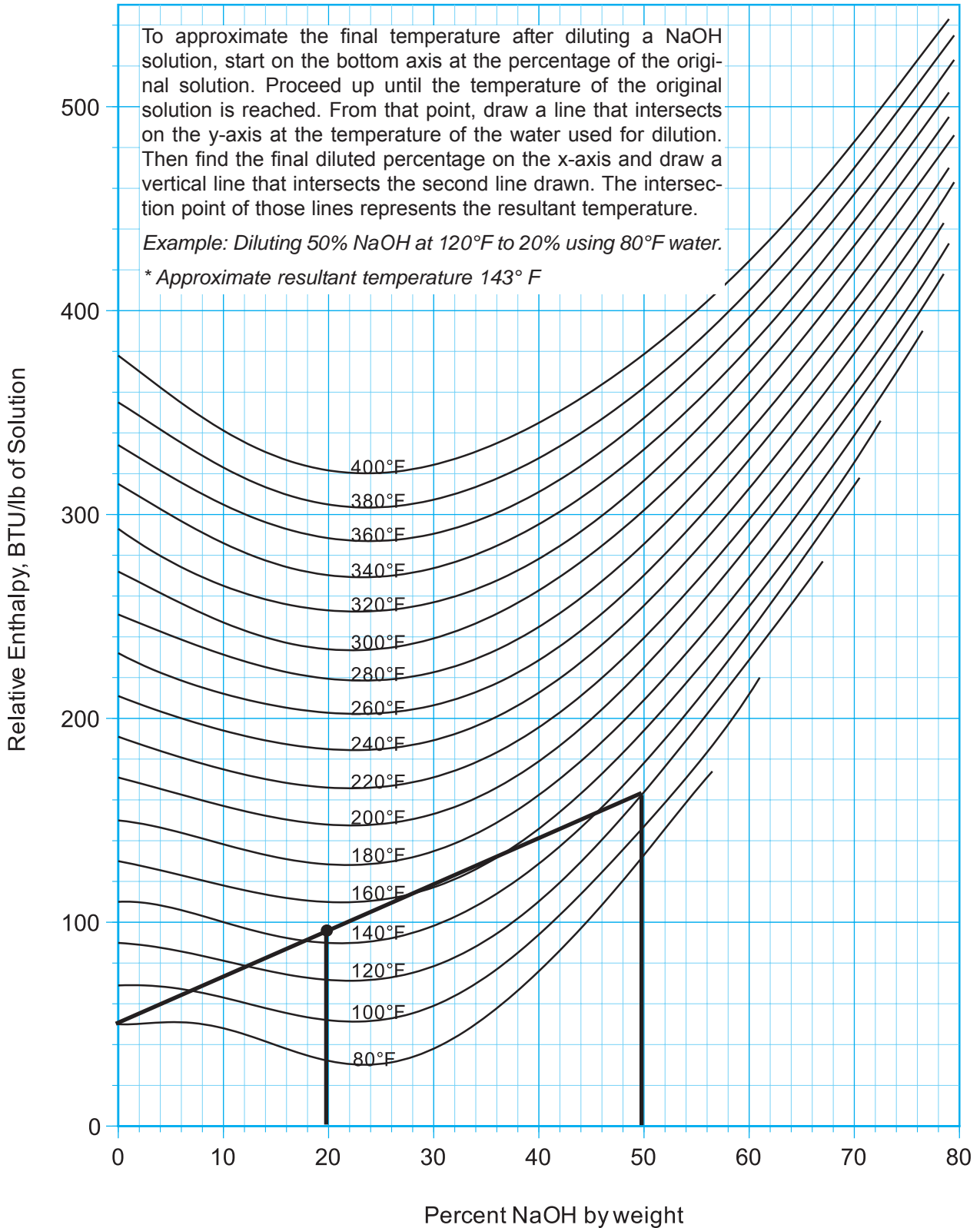

### Graph 7 Solubility of Sodium Chloride in Aqueous Caustic Soda Solutions

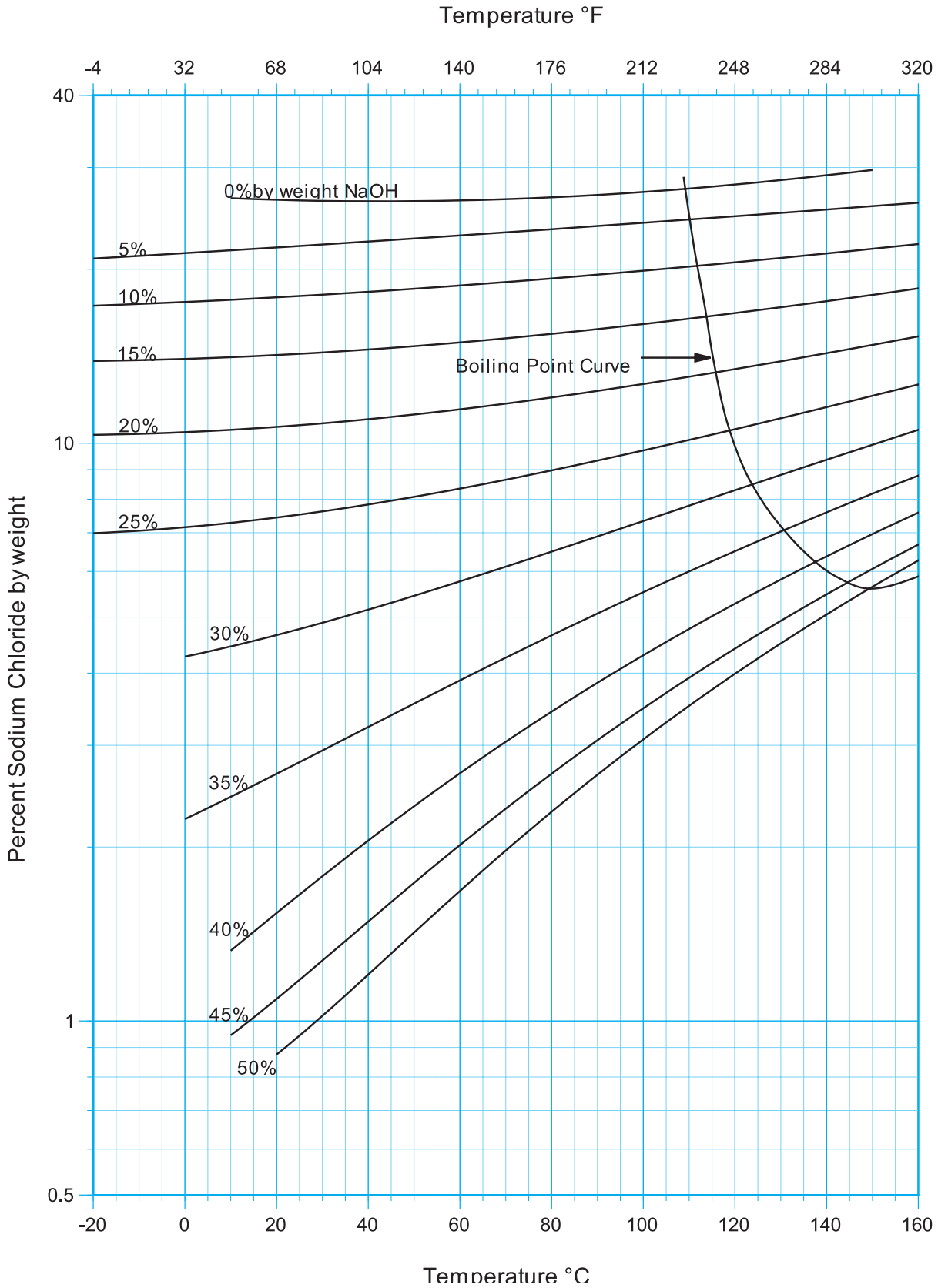

### Graph 8 Thermal Conductivity of Aqueous Caustic Soda Solutions

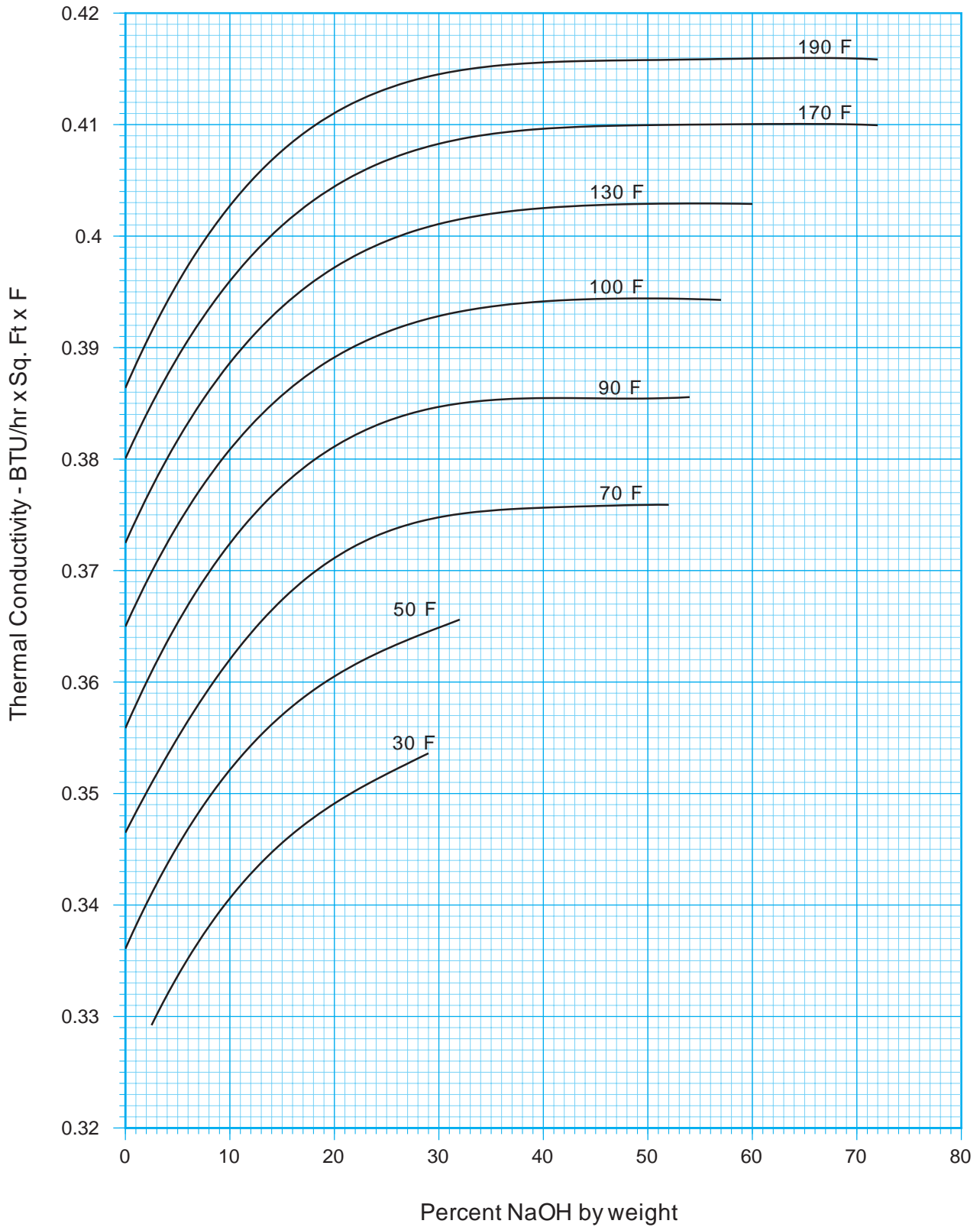

**Graph 9**  
**Specific Conductance of Aqueous Caustic Soda Solutions**

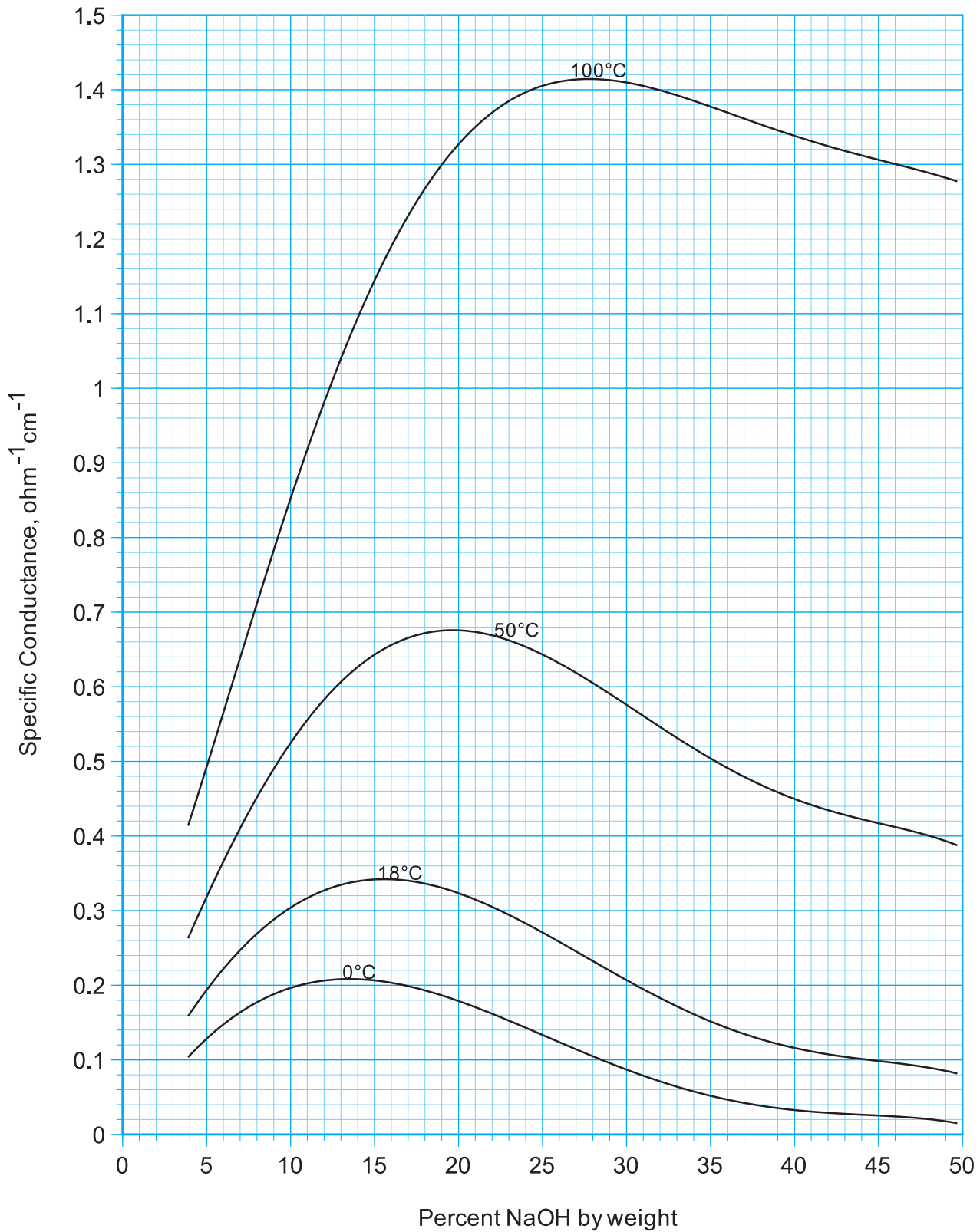

## HOW TO DILUTE CAUSTIC SODA SOLUTIONS

Sometimes it is necessary to dilute caustic soda before it is used, or when the potential for freezing exists. A procedure for calculating the amount of concentrated caustic and water required is given below.

### DILUTING A SOLUTION

**Problem:** To dilute 3,000 gallons of 50% NaOH to a 20% solution. How much water is necessary to accomplish this task?

**Solution:** The dilution can be simplified by using the following formula:

$$D=V[A(B-C)/C]$$

*Where:*

A=Specific gravity of strong solution

B=Concentration of strong solution (% NaOH)

C=Concentration of desired solution(% NaOH)

D=Volume of water to be added

V=Volume of strong solution

(The specific gravity of 50% NaOH is 1.5372 taken from Table 2)

*Therefore:*

$$D=3,000((1.5372)(50-20)/20)$$

$$D=3,000(2.3058)=6,917 \text{ gallons}$$

Result: It will take 6,917 gallons of water to dilute 3,000 gallons of 50% NaOH to a 20% solution.

### VOLUME OF FINAL SOLUTION

It should be noted that when diluting caustic soda, volumes are not additive. Therefore, in the previous example, the final volume of the solution would not be 6,917 gallons of water + 3,000 gallons of 50% NaOH = 9,917 total gallons. The actual volume will be slightly less. To calculate the final volume, the water and caustic soda must be converted to a weight basis, and then divided by the density of the desired solution.

### DILUTION GRAPH

Graph 10 can also be used to determine approximate volumes of 50% NaOH and water necessary to achieve a particular dilution. For example, you want to produce 3,000 gallons of a 25% NaOH solution and want to know how much water and 50% NaOH are needed to accomplish this goal.

Using the chart, start on the bottom axis at the 3,000 gallon line. Proceed upward until you intersect the first 25% line on the bottom half of the graph. From the intersection point go to the right and left axes to determine the volume and weight of water needed. In this case the volume is read at 1,920 gallons and the weight at 16,000 pounds.

Then continue upward until you intersect the 25% line at the top of the graph. Again from the intersection point go to the left and right axes to determine the volume and weight of 50% NaOH needed. In this case the volume is read at 1,248 gallons and the weight at 16,000 pounds.

Therefore, it would take 1,248 gallons of 50% NaOH to be added to 1,920 gallons of water to produce 3,000 gallons of a 25% solution.



# Dilution Calculations

**Graph 10**  
**Approximate Dilution Chart For 50% Caustic Soda**

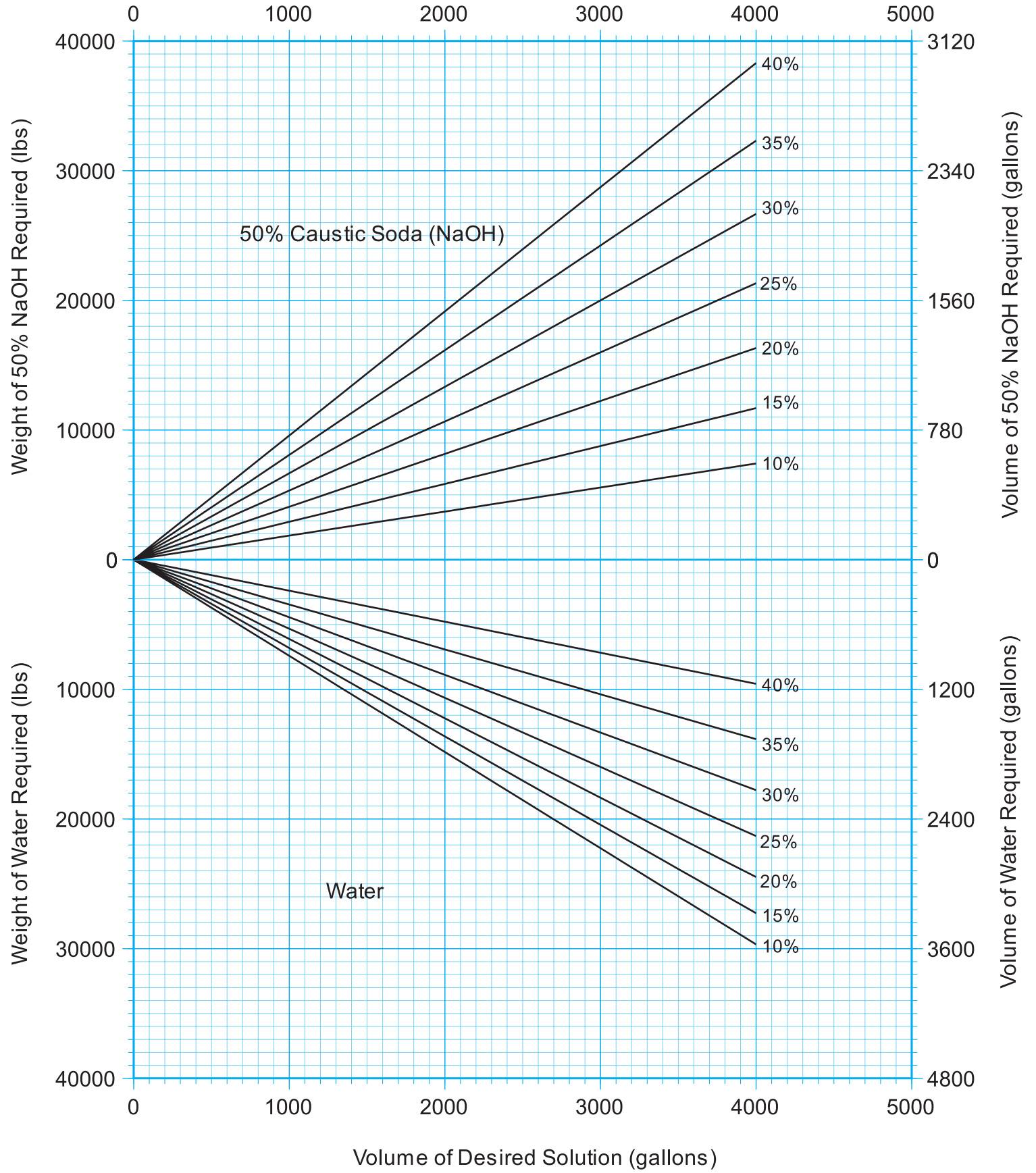

## DETERMINATION OF THE TOTAL ALKALINITY OF CAUSTIC SODA

### PURPOSE AND THEORY

The accurate determination of the total alkalinity value for caustic soda is necessary for calculating the correct billing concentrations of this product.

Total alkalinity in caustic soda products is determined by titration of a sample with a standardized solution of 1N hydrochloric acid. Modified methyl orange indicator is used to determine the titration endpoint.

This procedure is based on ASTM E291-04, Standard Test Methods for Chemical Analysis of Caustic Soda and Caustic Potash, sections 8 through 14.

### APPARATUS

**100 ml Buret;** Class A Volumetric, Fisher Scientific Cat #: 03-775 or equivalent.

**Analytical Balance;** capable of weighing to 0.001 grams.

**250 ml Erlenmeyer Flasks;** wide mouth, Fisher Cat#: 10-090B or equivalent.

**Magnetic Stirrer;** Fisher Cat#: 14-493-120S or equivalent.

**Magnetic stirring bars;** 1 1/2" x 5/16" dia. Fisher Cat#: 14-511-64 or equivalent.

### REAGENTS

**1N Hydrochloric Acid;** measure 83.0 ml of ACS Reagent grade concentrated hydrochloric acid into a graduated cylinder and transfer it to a one liter volumetric flask containing approximately 500 ml of deionized water. Dilute to volume with additional water, mix well and store in a tightly closed container. A prepared solution of 1N

HCl can also be purchased (Fisher Scientific Cat# SA48-20 or equivalent). Hydrochloric Acid must be standardized to  $\pm 0.0001N$  before use.

**Sodium Carbonate;**

anhydrous, volumetric grade (EM Science Cat#: 6394-2 or equivalent.) Dry at 250°C in a platinum or porcelain crucible for 4 hours. Store in a desiccator.

**Modified methyl orange indicator;** dissolve 0.14 grams of methyl orange (Fisher Cat#: M216-25) and 0.12 grams of Xylene Cyanole FF (Fisher Cat#: BP565-10) in deionized water and dilute to 100 ml.

**Water, Deionized & Carbon Dioxide free;** boil and cool the deionized water or purge it with nitrogen for two hours.

### SAFETY

Refer to the MSDS for the proper handling procedures for each of the chemicals listed in this procedure.

**Caustic soda is a strong base. Hydrochloric acid is a strong acid. These chemicals are corrosive to body tissue and can cause immediate and severe burns to eyes. Wear proper gloves, proper eye protection and other protective clothing when handling these chemicals.**

### PROCEDURE

#### A. STANDARDIZATION OF 1N HYDROCHLORIC ACID

1. Weigh 4.2 grams of sodium carbonate to the nearest 0.0001 gram into a weighing dish. Carefully transfer to an Erlenmeyer flask. Add 75 ml of deionized water and swirl to dissolve. Add three drops of the modified methyl orange indicator and titrate

with the HCl solution to a steel gray color change.

2. The following formula is used to calculate the normality of the HCl.

Let:

N = Normality of HCl

W = Weight (g) of  $Na_2CO_3$  used

V = Volume (ml) of HCl required to endpoint.

Milliequivalent weight of  $Na_2CO_3 = 0.053$

$N = W/V \times 0.053$

3. Determine the normality by averaging the result of at least three titrations.

#### B. ANALYSIS

1. To a clean, dry Erlenmeyer flask, accurately weigh, to the nearest 0.001 grams, 6 to 7 grams of 50% NaOH. Weighing should be performed as rapidly as possible.
2. Immediately add 50 ml of deionized water, making sure the sides of the beaker are washed down.
3. Add 3 to 4 drops of modified methyl orange indicator and carefully add the magnetic stirring bar.
4. Titrate the sample to a steel gray color with 1N HCl. Samples should be titrated as soon as possible to avoid pick up of carbon dioxide from the air.
5. Record the volume of acid required to reach this color. Estimate the buret reading to the nearest 0.02 ml.

## C. CALCULATIONS

The following are formulas used to calculate total alkalinity.

Let:

W = Weight (g) of sample titrated

N = Normality of HCl

V = Volume (ml) of HCl required

Milliequivalent wt. of Na<sub>2</sub>O =

0.03099

$$\% \text{Na}_2\text{O} = \frac{(V)(N)(0.03099)(100)}{W}$$

$$\% \text{NaOH} = 1.2907 (\% \text{Na}_2\text{O})$$

### EXAMPLE

6.530 grams of caustic soda required the addition of 81.77 ml of 1.0011N HCl to reach the modified methyl orange endpoint.

$$\% \text{Na}_2\text{O} = \frac{(V)(N)(0.03099)(100)}{W}$$

$$\% \text{Na}_2\text{O} = \frac{(81.77)(1.0011)(3.099)}{6.530}$$

$$\% \text{Na}_2\text{O} = 38.85\%$$

$$\% \text{NaOH} = (1.2907)(38.85)$$

$$\% \text{NaOH} = 50.14\%$$

## QUALITY ASSURANCE

With each batch of samples being analyzed, at least one of the samples should be analyzed in duplicate. On a regular basis, samples that have been previously analyzed for total alkalinity should be reanalyzed and the results compared.

Alkalinity values obtained for each sample should be compared with OxyChem specifications for that product. Hydrochloric acid should be restandardized at least monthly.

## DETERMINATION OF SODIUM HYDROXIDE IN CAUSTIC SODA

### PURPOSE AND THEORY

The sodium hydroxide content of caustic soda is determined by adding barium chloride to a prepared sample and titrating with 1 N HCl to the phenolphthalein end point. The results are reported as percent NaOH on a sample weight basis.

Even with the utmost care, the separate determination of total alkalinity (previous method) and hydroxide alkalinity often provides significant differences. This difference is then typically attributed to the presence of carbonate. It has been found that separate titrations for total alkalinity and hydroxide alkalinity, or dual end-point titrations that attempt to quantify total and hydroxide alkalinity in a single procedure, often provide results for carbonate that are many times higher than the actual carbonate content of the material.

Although the method for hydroxide alkalinity is included here, because the usual carbonate content of caustic soda is very low, we suggest the use of the method for total alkalinity alone. The carbonate content is typically as low as or lower than the measurement error inherent in the analytical methods. As an alternative, we suggest the use of the method for total alkalinity, the method for sodium carbonate determination (next method in this handbook), and a calculation for hydroxide alkalinity as shown in ASTM E291-04, Standard Test Methods for Chemical Analysis of Caustic Soda and Caustic Potash, section 12.

### APPARATUS

**100 ml Buret;** Class A Volumetric, Fisher Scientific Cat #: 03-775 or equivalent.

**Analytical Balance;** capable of weighing to 0.001 grams.

**250 ml Erlenmeyer Flasks;** wide mouth, Fisher Cat#: 10-090B or equivalent.

**Magnetic Stirrer;** Fisher Cat#: 14-493-120S or equivalent.

**Magnetic stirring bars;** 1-1/2" x 5/16" dia. Fisher Cat#: 14-511-64 or equivalent.

### REAGENTS

**1N Hydrochloric Acid;** the preparation of this reagent is described in the method for: "Determination of Total Alkalinity".

**1% Phenolphthalein Indicator;** dissolve one gram of phenolphthalein (Aldrich Cat#: 10,594-5 or equivalent) in 100 ml of methanol.

**10% Barium Chloride;** Dissolve 120 g of reagent grade BaCl<sub>2</sub>·2H<sub>2</sub>O (Fisher Cat#: B34-500) in 880 ml of deionized water.

**Water, Deionized & Carbon Dioxide free;** boil and cool the deionized water or purge it with nitrogen for two hours.

### SAFETY

**Refer to the MSDS for the proper handling procedures for each of the chemicals listed in this procedure. Caustic soda is a strong base. Hydrochloric acid is a strong acid. These chemicals are corrosive to body tissue and can cause immediate and severe burns to eyes. Wear proper gloves, proper eye protection and other protective clothing when handling these chemicals. Barium chloride is highly toxic. Avoid inhaling barium chloride dust.**

## PROCEDURE

### A. STANDARDIZATION OF 1N HYDROCHLORIC ACID

Standardization procedure is described in the method for: "Determination of Total Alkalinity".

### B. ANALYSIS

1. To a clean, dry Erlenmeyer flask, accurately weigh, to the nearest 0.001 grams, 6 to 7 grams of 50% NaOH. Weighing should be performed as rapidly as possible.
2. Immediately add 100 ml of barium chloride solution, making sure the sides of the beaker are washed down.
3. Add 3 to 4 drops of phenolphthalein indicator and carefully add the magnetic stirring bar.
4. Titrate the sample with 1N HCl until the pink color changes to water white. The sample should be titrated as soon as possible to avoid pick up of carbon dioxide from the air.
5. Record the volume of acid required to reach this color, estimating the buret reading to the nearest 0.02 ml.

### CALCULATIONS

The following are formulas used to calculate % NaOH.

Let:

W = Weight (g) of sample titrated

N = Normality of HCl

V = Volume (ml) of HCl required

Milliequivalent wt. of NaOH =

0.04000

$$\% \text{ NaOH} = \frac{(V) (N) (0.04000) (100)}{W}$$

W

### EXAMPLE

6.467 grams of caustic soda required the addition of 80.85 ml of 1.0020N HCl to reach the phenolphthalein endpoint.

$$\% \text{ NaOH} = \frac{(V) (N) (0.04000) (100)}{W}$$

$$\% \text{ NaOH} = \frac{(80.85) (1.0020) (4.000)}{6.467}$$

$$\% \text{ NaOH} = 50.11\%$$

### QUALITY ASSURANCE

For each batch of samples being analyzed, at least one of the samples should be analyzed in duplicate. On a regular basis, samples that have been previously analyzed for total alkalinity should be reanalyzed and the results compared. Alkalinity values obtained for each sample should be compared with OxyChem specifications.

Hydrochloric acid should be restandardized at least monthly.

## DETERMINATION OF SODIUM CARBONATE IN CAUSTIC SODA (Gravimetric)

## PURPOSE AND THEORY

The sodium carbonate content of a sample of caustic soda is determined by a direct gravimetric method. The method involves acidification of the caustic soda sample with dilute sulfuric acid, boiling, and weighing the carbon dioxide evolved. Accurate results can be obtained when the sodium carbonate content is 0.01% or greater. This method should be used to analyze samples of liquid caustic soda containing 0.01% to 0.25% Na<sub>2</sub>CO<sub>3</sub>.

This procedure is based on ASTM E291-04, Standard Test Methods for Chemical Analysis of Caustic Soda and Caustic Potash, sections 25 through 33. Although it is included as a reference for anyone who may wish to perform the analysis, it should be noted that the procedure is rather lengthy, may show poor precision and is susceptible to error because of air intrusion into the apparatus.

OxyChem typically utilizes a carbon analyzer in inorganic mode for the rapid and precise determination of carbonate content of caustic soda. For further information regarding the carbon analyzer method, please contact technical Service.

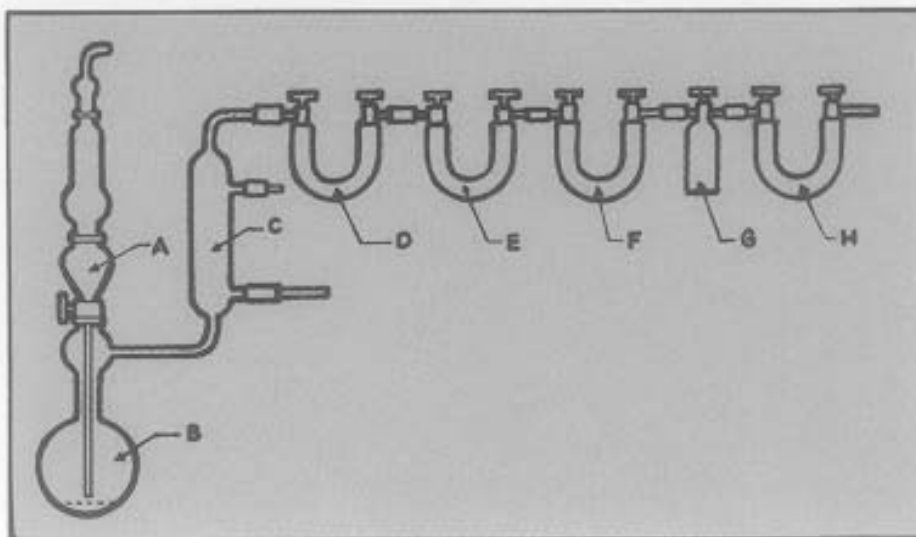

## APPARATUS

See the CO<sub>2</sub> train sketch on the previous page. Air for sweep is drawn in through "A." This air must be scrubbed free of CO<sub>2</sub>. The ground-glass jointed tube fitted into the top of "A" should be packed with 8-20 mesh ascarite with a layer of anhydrous granular copper sulfate on top.

### U-tube "D"

Add a few glass beads and 5 to 10 ml of concentrated H<sub>2</sub>SO<sub>4</sub>. The acid takes up the bulk of the moisture passing through condenser "C" and should be changed often depending on frequency of use.

### U-tube "E"

Pack with dehydrated copper sulfate pumice. This packing material is prepared by soaking pulverized pumice having the grain size of wheat in saturated copper sulfate solution drying at 150-180°F. The product must be kept in a well stoppered bottle.

### U-tube "F"

Pack with anhydrous magnesium perchlorate. This removes all final traces of moisture carried through the system.

### Ascarite - Absorbing Tower "G"

Pack inside tube with 8-20 mesh ascarite. Over the top layer add about 0.25 inch of magnesium perchlorate and cover with absorbent cotton. The cotton will prevent loss of weight due to carry-over of dust particles. After tower is packed, it should be hooked into the system and swept with CO<sub>2</sub>-free air for a period of 15 to 20 minutes.

### U-tube "H"

Pack with 8-20 mesh ascarite.

## REAGENTS

**Sulfuric Acid;** 12 N with 27.8 g.

FeSO<sub>4</sub>·7H<sub>2</sub>O per liter.

**Sulfuric Acid, concentrated.**

**Ascarite II;** 8-20 mesh (sodium hydroxide coated silica.)

**Magnesium Perchlorate, anhydrous.**

**Copper (II) Sulfate, anhydrous.**

**Water, Deionized & Carbon Dioxide free;** boil and cool the deionized water or purge it with nitrogen for two hours.

## SAFETY

**Caustic soda as dust or mist is intensely irritating to the respiratory system, skin, and eyes. Become familiar with the first aid measures recommended in this Handbook.**

**When preparing 12 N sulfuric acid, the concentrated acid must be poured slowly into water with constant stirring.**

**Wear safety glasses with side shields when handling caustic soda samples or acid solutions.**

## PROCEDURE

### 1. Sample Preparation

50% liquid caustic soda will solidify at 54°F. If the sample is solidified at the time of analysis, it may be thawed out by placing the container in hot water until no solids are present. The lip of the bottle may be wiped before the sample is poured into a weighing bottle.

Carbonate and moisture pickup should be avoided by rapid sample handling.

In all cases, samples for carbonate analysis should be the first taken from the sample bottle to minimize carbon dioxide pickup from the atmosphere.

### 2. Analysis

The train must be conditioned daily before any samples are run. This is done by making a regular determination using a sample that contains carbonate. Following this, a blank should be run on the train to make sure that the train is leak free. This is done by making a regular determination but omitting the sample. If the ascarite weighing tower gains more than 0.2 mg in weight during the blank run, the train probably has a leak.

After the train has been conditioned and found to be leak free, the samples are run as follows:

1. Two absorbing towers (G) must be conditioned and weighed prior to analysis. These will be called G1 and G2 in the procedure. The use of two towers will enable the analyst to conserve time when performing more than one analysis.
2. Weigh a sample of at least 20g. (50% basis) or large enough to contain 5 mg of CO<sub>2</sub> into a flask "B" using an analytical balance. Add 4 or 5 glass beads and 80 ml of CO<sub>2</sub>-free deionized water and immediately place the flask into its proper position in the train.
3. Add 50 ml of 12 N sulfuric acid to funnel "A."
4. Place tared tower G1 between U-tubes "F" and "H."
5. Open the system starting at U-tube "H" and working back to "D."
6. Open cock on funnel "A" and allow acid to run into flask "B" and immediately hook vacuum line to tube "H." Adjust the flow of air to 4 bubbles per second through the tip of the stem of funnel "A."

7. Apply heat to flask "B" and bring to a boil. Hold "B" contents to boiling point for 3 minutes and remove heat.
8. Sweep the system for 20 minutes. While this is being done, the next sample can be weighed into another flask (B), and the beads and distilled water added. This flask is then stoppered and set aside until needed.
9. At the end of 20 minutes, the vacuum line is removed, tower G1 is shut off and removed and tower G2 placed into position. The cock on funnel "A" is closed and 50 ml of 12 N sulfuric acid is again added to funnel "A."
10. Flask "B" is removed, the stem of funnel "A" is washed down with deionized water and the new sample is placed into position.
11. Tower G2 is opened and the procedure is repeated beginning at Step 6.
12. When G1 is removed from the train, a period of 20 minutes will

condition the sample for weighing. During this 20 minute sweep time, another sample is prepared and tower G1 is reweighed in order to determine the weight of CO<sub>2</sub> found in the first sample. Tower G1 is then ready for Run No. 3.

## CALCULATIONS

Report results as percent Na<sub>2</sub>CO<sub>3</sub> calculated to the nearest 0.01. Let:  
 $W(\text{CO}_2) = \text{Weight of CO}_2 \text{ evolved}$

$$W(S) = \text{Weight of sample}$$
$$\% \text{ Na}_2\text{CO}_3 = \frac{W(\text{CO}_2)(2.409)(100)}{W(S)}$$

## EXAMPLE

If a 25 gram sample were used and the weight of CO<sub>2</sub> absorbed in tower "G" = 0.0125 grams, then:

$$\% \text{ Na}_2\text{CO}_3 = \frac{(0.0125)(2.409)(100)}{25}$$

$$\% \text{ Na}_2\text{CO}_3 = 0.12\%$$

## DETERMINATION OF SODIUM CHLORIDE IN CAUSTIC SODA

### PURPOSE AND THEORY

Chloride is a contaminant in all grades of caustic soda. Sodium chloride is present at <100 ppm in 50% membrane caustic soda and at approximately 1% in 50% diaphragm caustic soda. Higher concentrations of this compound can have undesirable effects in many applications of the product. Consequently, accurate determination of this impurity is most important.

When acid solutions of silver ion and an alkali thiocyanate are mixed in the presence of a ferric salt, the thiocyanate has a selective action toward silver, resulting in the formation of silver thiocyanate. Any

excess of thiocyanate not required by the silver reacts with ferric salt to form reddish-brown ferric thiocyanate. This color indicates the completion of the reaction.

An excess of silver nitrate and the ferric indicator is added to a sample of caustic soda that has been acidified with nitric acid. Any chloride that is contained in the sample will react with the silver nitrate to form a silver chloride precipitate. The silver nitrate that is remaining in the sample solution after this reaction is titrated with a standardized solution of ammonium thiocyanate. The equations involved are:

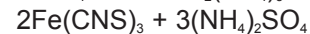
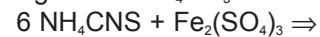
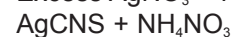
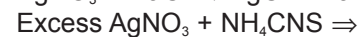
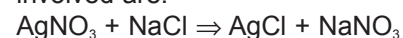

(reddish brown color)

This procedure is based on ASTM E291-04, Standard Test Methods for Chemical Analysis of Caustic Soda and Caustic Potash, sections 34 through 40.

OxyChem typically utilizes turbidimetric determination, potentiometric titration (similar to ASTM E29-104, sections 41 through 48, with modifications to account for the low chloride content of membrane grade caustic soda) or ion chromatography. For further information regarding any of these methodologies, please contact Technical Service.

## APPARATUS

**25ml Buret;** Class A Volumetric, Fisher Scientific Cat#:03-724-10A or equivalent.

**20ml Pipet;** Class A Volumetric, Fisher Cat#: 13-650-2N

**500ml Erlenmeyer flasks;** wide mouth, Fisher Cat#: 10-090C or equivalent.

**Magnetic stirrer;** Fisher Cat#:14-493-120S or equivalent.

**Magnetic stirring bars;** 1 1/2" x 5/16" dia, Fisher Cat#: 14-511-64 or equivalent.

**Analytical Balance;** capable of weighing to 0.001 grams.

## REAGENTS

**Water, Deionized.**

**0.1N Silver Nitrate;** accurately weigh 16.99 grams of ACS Reagent grade silver nitrate (dried at 110°C for 1 hr) and transfer to a 1L volumetric flask. Dilute to volume with deionized water, mix well and store in a tightly closed amber container. Silver nitrate and its aqueous solutions are photodecomposed by light and should be stored in a dark place.

**0.1N Ammonium Thiocyanate;** accurately weigh 7.612 grams of ACS Reagent grade ammonium thiocyanate and transfer to a one volumetric flask. Dilute to volume with deionized water, mix well and store in a tightly stoppered glass bottle. The thiocyanate solution must be standardized to within  $\pm 0.0001N$  prior to use.

**Ferric Indicator;** prepare a saturated aqueous solution of ferric ammonium sulfate  $[FeNH_4(SO_4)_2]$ , Aldrich Cat# 22,126-0 or equivalent.

**1% Phenolphthalein Indicator;** dissolve one gram of phenolphthalein (Aldrich Cat#: 10,594-5 or equivalent) in 100 ml of methanol.

**Nitric Acid,** 1:1 (v/v); slowly pour 500 ml of ACS Reagent grade nitric acid in 500 ml of deionized water as it is stirring. Allow the solution to cool.

## SAFETY

Refer to the MSDS for the proper handling procedures for each of the chemicals listed in this method.

Caustic soda is a strong base and nitric acid is a strong acid. These chemicals are corrosive to body tissue and can cause immediate and severe burns to eyes. Wear proper gloves, proper eye protection and other protective clothing when handling these chemicals.

Silver Nitrate is a strong oxidizing agent. Wear rubber gloves when handling. Contact with skin causes a black discoloration. Keep away from heat, sparks and open flames.

## PROCEDURE

### A. STANDARDIZATION OF 0.1N SILVER NITRATE

Since this procedure determines the chloride content of a sample by comparing the amount of unreacted silver nitrate remaining in a sample with the amount that is remaining in a reagent blank, the exact normality of the silver nitrate need not be known. If a reagent blank is not used, silver nitrate standardization is essential. A manual titration method is described in "ASTM Standard Practice for Preparation, Standardization and Storage of Standard Solutions for Chemical Analysis", Vol 15.05; E200-91, 44-48.

### B. STANDARDIZATION OF 0.1N AMMONIUM THIOCYANATE

1. Use a volumetric pipet to transfer 20.00 ml of freshly standardized 0.1 N silver nitrate into a 250 ml Erlenmeyer flask containing 50 ml deionized water, 5 ml of 1:1 nitric acid and 1 ml of ferric indicator. Titrate the  $AgNO_3$  with the  $NH_4SCN$  solution until the first permanent reddish-brown color appears and persists after vigorous shaking for 15 seconds. Record the volume of  $NH_4SCN$  required. Repeat the above procedure on at least three more solutions of silver nitrate.
2. Use the following formula to calculate the normality of the ammonium thiocyanate solution:  
$$N1 = (N2)(V2)/(V1)$$
where:  
N1 = Normality of  $NH_4SCN$   
N2 = Normality of  $AgNO_3$   
V1 = Volume of  $NH_4SCN$  required  
V2 = Volume of  $AgNO_3$  added
3. Determine the normality by averaging the results of at least three titrations.

### C. PROCEDURE

1. To a clean dry Erlenmeyer flask, accurately weigh, to the nearest 0.001 g for smaller samples and 0.01 g for larger samples, an amount of product as determined in the following table. Weighing should be performed as rapidly as possible.

### SAMPLE SIZE FOR CHLORIDE ANALYSIS

Product	Sample size
50% Diaphragm grade caustic soda	.6 g
50% Membrane grade caustic soda	.80 g

2. Immediately add 100 ml of deionized water, making sure the sides of the beaker are washed down.
3. Add 2 drops of 1% phenolphthalein indicator and carefully neutralize the sample with 1:1 nitric acid. **Caution: The sample solutions generate considerable heat when being neutralized with acid. The flask should be continuously cooled in an ice bath while the acid is slowly added. After the phenolphthalein endpoint has been reached (color changes from pink to colorless), add an additional 5.0 ml of acid.**
4. Allow the solution to cool to room temperature and add a stirring bar to the flask.
5. Using a volumetric pipet add 20.00 ml of 0.1N silver nitrate, also add approximately 1 ml of the ferric indicator solution (see Note 1).
6. Prepare a reagent blank by adding two drops of phenolphthalein, 5ml nitric acid, 20.00 ml silver nitrate solution and 1ml of ferric indicator to a flask containing 100 ml of deionized water and a stirring bar.
7. Place the flask containing the reagent blank on a magnetic stirrer and titrate the solution with 0.1N ammonium thiocyanate until a reddish-brown color persists for at least 15 seconds (see Note 2). Record the volume of  $\text{NH}_4\text{SCN}$  required to reach the color change.
8. Titrate the sample solution with 0.1N ammonium thiocyanate until the same color change is reached and record the volume of  $\text{NH}_4\text{SCN}$  (see Notes 3 and 4).

## D. CALCULATIONS

The following is the formula used to calculate the percent chloride in the sample.

Let:

W = Weight of sample titrated

N = Normality of  $\text{NH}_4\text{SCN}$

V1= Volume of  $\text{NH}_4\text{SCN}$  required to titrate blank

V2= Volume of  $\text{NH}_4\text{SCN}$  required to titrate sample

Milliequivalent wt. of Cl = 0.03545

$$\% \text{ Cl} = \frac{(V1-V2)(N)(0.03545)(100)}{W}$$

Calculate the percentage of sodium chloride as follows:

$$\% \text{ NaCl} = (\% \text{ Cl})(1.6485)$$

## EXAMPLE

79.28 grams of 50% Membrane grade caustic soda required the addition of 19.54 ml of 0.1005 N  $\text{NH}_4\text{SCN}$  to reach the titration endpoint while the reagent blank required 19.95 ml of  $\text{NH}_4\text{SCN}$  to reach the same endpoint.

$$\% \text{ Cl} = \frac{(V1-V2)(N)(0.03545)(100)}{W}$$

$$= \frac{(19.95-19.54)(0.1005)(3.545)}{79.28}$$

$$\% \text{ Cl} = 0.00180$$

$$\% \text{ NaCl} = (\% \text{ Cl})(1.6485)$$

$$\% \text{ NaCl} = (0.00180)(1.6485)$$

$$\% \text{ NaCl} = 0.0030\% \text{ or } 30 \text{ ppm}$$

## NOTES

1. Sample solutions should be titrated within several minutes of adding the silver nitrate. The silver chloride has a tendency to decompose with exposure to light giving the solution a purplish color. This color can inter-

fere with an accurate determination of the endpoint color change.

2. From the outset of the back-titration with ammonium thiocyanate, an appreciable quantity of silver ions are absorbed on the surface of the precipitates. Because of this, there is a tendency for a premature appearance of the endpoint color. Vigorous stirring or shaking of the solution is essential to bring about desorption of silver ions from the precipitates so they can react with the thiocyanate.
3. As the endpoint is approached, increasing amounts of silver thiocyanate precipitating out of solution will actually increase the solubility of silver chloride. Silver chloride that has precipitated will redissolve, allowing additional silver ions to react with the thiocyanate. This causes a fading endpoint and results in low chloride values. For samples containing concentrations of chloride greater than 0.01%, it is advisable to filter the sample solution through semi-quantitative paper after the addition of silver nitrate but prior to titration with thiocyanate. Removing most of this precipitate will greatly decrease the amount of silver that can be redissolved during the titration.
4. The white precipitate of silver thiocyanate interferes with observation of the color change at the titration endpoint. It is sometimes helpful to stop the stirring or shaking of the sample and allow the precipitate to settle, in order to observe the color of the sample solution. If it is determined during this observation that the endpoint has not yet been reached, resume vigorous stirring before addition of more  $\text{NH}_4\text{SCN}$ .



## QUALITY ASSURANCE

Because of difficulties in determining the exact endpoint when using this method, only skilled laboratory personnel should attempt to perform these titrations.

On a regular basis, samples that have been previously analyzed for chloride content should be reanalyzed and the results compared.

Chloride values should be checked against OxyChem specifications.

## DETERMINATION OF IRON IN CAUSTIC SODA

### PURPOSE AND THEORY

Iron can result from contamination during storage or transport of the product. Since iron is often detrimental to the end use of the product, accurate quantitation of this element is essential.

Caustic soda is neutralized with hydrochloric acid and the resulting solution buffered with sodium acetate. Hydroxylamine hydrochloride reduces any iron present in the ferric state to the ferrous state. o-phenanthroline (1,10-phenanthroline) forms an orange-red complex with ferrous iron. The intensity of the color is proportional to the amount of iron present. By measuring the color intensity with a spectrophotometer, the concentration of iron in a sample of caustic soda can be determined.

This procedure is based on ASTM E291-04, Standard Test Methods for Chemical Analysis of Caustic Soda and Caustic Potash, Sections 58 through 66.

## APPARATUS

**Visible Spectrophotometer:** able to measure absorbance or percent transmittance at 510 nanometers.

**Analytical Balance:** capable of reading to 0.01 grams.

**Volumetric Flask, 1 l, class A:** Fisher catalog # 10-210-8G or equivalent

**Volumetric Flask, 100 ml, class A:** Fisher catalog # 10-210-8C or equivalent

**Pipets, Volumetric, Class A:**  
1 ml - Fisher catalog # 13-650B or equivalent  
2 ml - Fisher catalog # 13-650C or equivalent  
5 ml - Fisher catalog # 13-650F or equivalent  
10 ml - Fisher catalog # 13-650L or equivalent

15 ml - Fisher catalog # 13-650M or equivalent

**Indicator Paper, Hydrion, pH 3.0 to 5.5:** Fisher catalog # 14-853-70 or equivalent)

**Disposable plastic pipets** ("Dispo-pipet")

**Cuvettes, quartz:** appropriate to the spectrophotometer in use, 25 mm diameter is typical but other path lengths providing detection limits suitable for the user are acceptable

## REAGENTS

### Deionized Water

**Hydrochloric Acid, concentrated:** reagent grade, Fisher catalog # A144 or equivalent

**Sodium Acetate, 164 grams per liter:** weigh 164.0 (+/- 0.1) grams of sodium acetate, Fisher catalog # S210-500 or equivalent, dissolve and dilute to 1 liter with deionized water in a 1 liter volumetric flask

**Hydroxylamine Hydrochloride, 100 grams per liter:** weigh 100.0 (+/- 0.1) grams of hydroxylamine hydrochloride, Fisher catalog # H330-500 or equivalent, dissolve and dilute to 1 liter with deionized water in a 1 liter volumetric flask  
**o-phenanthroline, 0.25 %:** weigh 2.50 (+/- 0.05) grams of o-phenanthroline monohydrate, Fisher catalog # P70-10 or equivalent, dissolve and dilute to 1 liter with deionized water in a 1 liter volumetric flask

**1000 µg/ml Iron Standard, suitable for ICP/AA, Spex standard available from Fisher as catalog # PLFE2-2Y or equivalent**

## SAFETY

**Refer to the MSDS for the proper handling procedures for each of the chemicals listed in this procedure.**

**Caustic soda is a strong base. Hydrochloric acid is a strong acid. The Iron Reference Solution is acidified with HCl. All of these chemicals are corrosive to body tissue and can cause immediate and severe burns to eyes. Wear proper gloves, proper eye protection and other protective clothing when handling these materials.**

**Refer to instrument manual for the proper use of equipment described in this method.**

## PROCEDURE

### A. SAMPLE ANALYSIS

1. Weigh the appropriate sample, based on the table below, into a clean 100 ml volumetric flask. Record the sample weight.  
50% diaphragm grade caustic soda 5-10 g  
50% membrane grade caustic soda 15-20 g
2. Add deionized water to the flask, such that the flask is slightly less than half-full, and swirl to mix the solution.

3. SLOWLY and CAREFULLY, add concentrated hydrochloric acid to the flask while constantly swirling the flask. Continue to add until the solution is just acidic. Check the pH by dipping a clean glass rod into the flask and touching the rod to the pH indicator paper. If acidic, the paper will turn red. If it is still basic, the paper will be blue. (If another type of indicator paper is used, verify the appropriate colors for the paper you are using.)

- CAUTION:** This is a reaction involving a strong base and a strong acid. Be sure to add the acid slowly and to maintain swirling so that spattering does not occur. The solution and flask will become quite warm. Cool the flask in an ice bath or under cold running water if desired.
4. If additional samples are to be analyzed, repeat steps 1 to 3 above for each sample.
  5. Prepare a blank by adding about 40 mls of deionized water and about 2 mls of concentrated hydrochloric acid to a separate, clean 100 ml volumetric flask.
  6. Using a dispo-pipet, add sufficient sodium acetate solution to the flasks (the samples and the blank) to buffer the solution to pH 3.5 +/- 0.5 pH units. Check the pH by dipping a clean glass rod into the flask and touching the rod to the pH indicator paper. At the proper pH, the paper will have a light green color. (If another type of indicator paper is used, verify the appropriate color for the paper you are using.)
  7. Pipet 5 mls of hydroxylamine hydrochloride solution to each flask.
  8. Pipet 5 mls of o-phenanthroline solution to each flask.
  9. Fill the flasks to volume with deionized water and shake well

to mix. Allow a minimum of 15 minutes for color development but complete the reading of the samples within 30 minutes.

10. Rinse a clean cuvette twice with small portions of the blank solution. Then fill the cuvette with the blank solution. Assure that there are no bubbles present and wipe off the outside of the cuvette with a soft, lint-free tissue. Place the cuvette into the spectrophotometer and zero the instrument at 0 (zero) absorbance (A) or 100% transmittance (T). Operate the spectrophotometer as directed in your instrument manual. Remove the cuvette from the instrument.
11. Fill a cuvette with the sample solution and load it into the spectrophotometer in the same fashion as described in step 9 above. Record the instrument reading as either A or T, depending upon how your calibration curve was constructed. (See section C below.)

## B. QUALITY CONTROL

1. Perform a duplicate analysis with each batch of samples. Simply repeat the Sample Analysis in section A above using an additional aliquot of a sample. If large numbers of samples are tested, it is suggested that a duplicate analysis is performed on one of every ten samples.
2. Perform a sample spike analysis with each batch of samples. To do so, prepare a second aliquot of a sample as directed in steps 1 and 2 of the Sample Analysis in section A above. Then pipet 2 mls of the 10 µg/ml iron stock standard (see step 1 in section C below) into the flask. Complete the sample preparation as described in the remaining steps of section A. This procedure provides about a 1 (one) µg/g (1 ppm) spike for membrane caustic soda or about a 2 to 4 µg/g (2

to 4 ppm) spike for diaphragm caustic soda. Different spike levels may be obtained by adding more or less of the iron stock standard or using different iron concentration solutions.

3. The relative percent difference between duplicates should be no more than 20%.
4. The spike recovery should be in the 80% to 120% range.

## C. SPECTROPHOTOMETER CALIBRATION

1. Prepare a stock 10 µg/ml iron standard by pipetting 1 ml of the 1000 µg/ml iron standard to a 100 ml volumetric flask and diluting to volume with deionized water.
2. Obtain six 100 ml volumetric flasks and label them as 'Blank', '10 µg', '20 µg', '50 µg', '100 µg' and '150 µg'. To each of these, add about 25 mls of deionized water and 2 mls of concentrated hydrochloric acid.
3. Pipet 1 ml of the 10 µg/ml iron stock standard (prepared in step 1 above) to the flask labeled '10 µg'. Similarly, pipet 2 mls of the iron stock to the flask labeled '20 µg', 5 mls to the flask labeled '50 µg', 10 mls to the flask labeled '100 µg', and 15 mls to the flask labeled '150 µg'.
4. Complete the preparation and reading of the standards by following steps 6 through 11 in section A above.
5. Many spectrophotometers will allow storing the calibration curve directly on the instrument. If this is not the case, you may wish to use a least squares regression analysis to store the

calibration on a calculator or PC program. Finally, calibration curves may be drawn manually using normal graph paper if plotting concentration vs. absorbance (A) or semi-log paper if plotting concentration (linear axis) vs. transmittance (T - log axis).

## CALCULATION

Calculate the ppm iron by dividing the micrograms of iron found from the calibration curve (C) by the sample weight (W):

$$\text{ppm Fe} = C / W$$

## DETERMINATION OF OTHER ELEMENTS IN CAUSTIC SODA

OxyChem typically utilizes Inductively Coupled Argon Plasma-Atomic Emission Spectroscopy (ICAP-AES) for the analysis of metals or elements in caustic soda.

For the determination of mercury, an automated cold vapor atomic absorption (CVAA) method, based on EPA Method 245.1 and ASTM E538, is utilized.

Since the operation of these instruments varies from manufacturer to manufacturer, a specific method is not included here. Follow your instrument manufacturer's instructions and recommendations for performing analysis of this type.

## IMPORTANT!!!

Regardless of the brand of instrument, it is necessary to keep in mind that calibration standards must be similar to the sample being analyzed if results are to be considered accurate.

Caustic soda will form a significant amount of salt when neutralized: for example, sodium chloride if neutralized with hydrochloric acid or sodium nitrate if neutralized with nitric acid. Since the sample contains a high amount of dissolved solids, calibration standards must be prepared in a similar matrix or sample results will be in error.

One means of addressing this is to prepare standards containing the same amount of dissolved salt that a sample would contain. This requires obtaining high purity salts, which can be quite costly. Another more economical means of accomplishing the "matrix match" is to use calibration by standard addition.

In general, analytical results obtained for elements in caustic soda will be significantly higher than the actual values if the samples are analyzed using a calibration based on "clean" aqueous standards as might be used for water analysis.

® Viton is a registered trademark of DuPont de Nemours.

® Teflon is a registered trademark of DuPont de Nemours.

® Hastelloy is a registered trademark of Haynes International.

® Inconel is a registered trademark of Inco Limited.

® Monel is a registered trademark of Inco Limited.